

	DATE	EC NO.	PART NO.
REL	NOV/17/04	J79027	39T0120
			DEVELOPMENT NO.
			Q/M
			1 /88

# ROME-4 PLANAR SVT

VER 0.90  
NOV/17/2004

- |                                      |   |
|--------------------------------------|---|
| 1. TITLE PAGE                        | 45. CDC CONNECTOR                       |
| 2. EC HISTORY                        | 46. CARDBUS CONTROLLER(1/2)             |
| 3. CPU(1/3)                          | 47. CARDBUS CONTROLLER(2/2)             |
| 4. CPU(2/3)                          | 48. CARDBUS/EXC SLOT                    |
| 5. CPU(3/3)                          | 49. CARDBUS/EXC PWR CTRL                |
| 6. ITP CON/LARGE PTH HOLE/EMI FINGER | 50. < BLANK PAGE >                      |
| 7. VCCCPUCORE DECOUPLING             | 51. GBE BCM5751M(1/2)                   |
| 8. ALVISO(1/7) : HOST I/F            | 52. GBE BCM5751M(2/2)                   |
| 9. ALVISO(2/7) : DDR2-A              | 53. GBE MAGNETICS                       |
| 10. ALVISO(3/7) : DDR2-B             | 54. RJ11/RJ45 CONNECTOR                 |
| 11. ALVISO(4/7) : PEG/DMI            | 55. MINI PCI SLOT                       |
| 12. ALVISO(5/7) : GRAPHICS           | 56. PCI BUS SWITCH                      |
| 13. ALVISO(6/7) : VCC/GND            | 57. DOCKING CONNECTOR                   |
| 14. ALVISO(7/7) : VCC/GND(NTCF)      | 58. H8S/2161B                           |
| 15. DDR2 SODIMM-A                    | 59. KEYBOARD CONNECTOR                  |
| 16. DDR2 SODIMM-B                    | 60. TOUCH PAD CONNECTOR                 |
| 17. DDR2 TERMINATION                 | 61. MISC G/A (PMH6)                     |
| 18. DDR2 DECOUPLING                  | 62. IO KEEPER(SUPER I/O, TPM, RFTD)     |
| 19. CLOCK GEN(CK410M)                | 63. PARALLEL INTERFACE                  |
| 20. ATI M24(1/6) : PEG I/F           | 64. SERIAL INTERFACE                    |
| 21. ATI M24(2/6) : LVDS/CRT/TV/TMDS  | 65. IR MODULE                           |
| 22. ATI M24(3/6) : CLK/GPIO          | 66. THERMAL SENSOR                      |
| 23. ATI M24(4/6) : ANALOG POWER      | 67. I2CBUS/SMBUS                        |
| 24. ATI M24(5/6) : VCC               | 68. FAN CONTROL                         |
| 25. ATI M24(6/6) : GND               | 69. G-SENSOR                            |
| 26. LCD CONNECTOR                    | 70. EMC DECOUPLING                      |
| 27. EXT CRT INTERFACE                | 71. RGB SWITCH                          |
| 28. TV_OUT                           | 72. DC-IN AND CHARGER (ADP3806)         |
| 29. ICH6-M(1/4) : DMI/PCI/LPC/AC97   | 73. CHARGE SELECTOR                     |
| 30. ICH6-M(2/4) : ATA/USB/PM         | 74. BATTERY INPUT                       |
| 31. ICH6-M(3/4) : PCI EXPRESS        | 75. BATTERY MONITOR                     |
| 32. ICH6-M(4/4) : VCC/GND            | 76. POWER SEQUENCE                      |
| 33. FWH,RTC BATTERY                  | 77. DC-DC VCC3M/VCC5M (MAX1901ETJ)      |
| 34. SATA BRIDGE/HDD CONN             | 78. DC-DC VCCCPUCORE (ADP3205)          |
| 35. BAY I/F CONN                     | 79. DC-DC VCORE INPUT CAP               |
| 36. USB POWER/CONN                   | 80. DC-DC VCC1R8M (MAX1993ETG)          |
| 37. AUDIO AD1981B                    | 81. DC-DC VCC1R5M/VCC1R05B (MAX1540ETJ) |
| 38. AUDIO MISC                       | 82. DC-DC VCCVIDEOCORE (MAX1993ETG)     |
| 39. AUDIO INT MIC                    | 83. DC-DC VCC2R5M/VCC0R9B               |
| 40. AUDIO HP & EXT MIC CONN          | 84. TSURUMAI-2                          |
| 41. AUDIO EXT MIC AMP                | 85. LOAD SW 1 (VIDEO)                   |
| 42. AUDIO SPEAKER                    | 86. LOAD SW 2 (AUX)                     |
| 43. AUDIO HDP AMP AN12943A(1/2)      | 87. LOAD SW 3 (B,UBAY)                  |
| 44. AUDIO HDP AMP AN12943A(2/2)      | 88. MAX POWER CTRL                      |

39T0120

DESIGNER	Y.I	NOV/17/04	PART NO.	39T0120	
CHECKED	Y.Y	NOV/17/04			
APPROVED	T.S	NOV/17/04	TITLE ROME-4 SVT(V0.90)		
CLASS	T.S	NOV/17/04	TITLE PAGE		
THIS DOCUMENT IS THE PROPERTY OF IBM ITS USE IS AUTHORIZED ONLY FOR RESPONDING TO A REQUEST FOR QUOTATION OR FOR THE PERFORMANCE OF WORK FOR IBM. ALL QUESTIONS MUST BE REFERRED TO THE IBM PURCHASING DEPARTMENT.				IBM CONFIDENTIAL	

# EC HISTORY

	DATE	EC NO.	PART NO.
REL	NOV/17/04	J79027	39T0120
			DEVELOPMENT NO.
			Q/M
			2 /88

## PRE-DV

VER.0.28 12/05/2003 RM4\_SDV\_EC\_108 , 111 TO 112  
 VER.0.29 12/08/2003 RM4\_SDV\_EC\_113 TO 116  
 VER.0.30 12/09/2003 RM4\_SDV\_EC\_117 TO 121  
 VER.0.31 12/16/2003 RM4\_SDV\_EC\_122 TO 125

PRE-DV GERBER RELEASED 12/17/2003

VER.0.32 01/07/2004 RM4\_SDV\_EC\_126 AND CHANGE R130 TO 150.

## SDV

VER.0.33 01/07/2004 RM4\_SDV\_EC\_127  
 VER.0.34 01/16/2004 RM4\_SDV\_EC\_128/129/130/131  
 VER.0.35 01/20/2004 RM4\_SDV\_EC\_133/135  
 VER.0.36 01/23/2004 RM4\_SDV\_EC\_137  
 VER.0.37 01/27/2004 RM4\_SDV\_EC\_138 TO 141  
 VER.0.38 02/03/2004 RM4\_SDV\_EC\_142--148  
 VER.0.39 02/04/2004 RM4\_SDV\_EC\_149/150/151/152  
 VER.0.40 02/06/2004 RM4\_SDV\_EC\_153/154/155/156/157  
 VER.0.41 02/12/2004 RM4\_SDV\_EC\_158/159/160/161/162  
 VER.0.42 02/16/2004 RM4\_SDV\_EC\_163

SDV GERBER RELEASED 02/17/2004

VER.0.43 02/18/2004 RM4\_SDV\_EC\_164/165/166

## SIV

VER.0.44 03/26/2004 RM4\_SIV\_EC\_001/002  
 VER.0.45 04/01/2004 RM4\_SIV\_EC\_003 TO 008 AND 012  
 VER.0.46 04/05/2004 RM4\_SIV\_EC\_09/10/14/19/20/21/22/23/24  
 VER.0.47 04/07/2004 CORRECT R872 TO NO-ASMRM AND J31 CRT CONN WIRING.  
 VER.0.48 04/08/2004 RM4\_SIV\_EC\_027/28/30/31/34/35  
 VER.0.49 04/11/2004 RM4\_SIV\_EC\_35 CORRECTION (R41->ASM) AND  
 AND ADD EZJ1V270GA X7 (ESD REASON).

SIV GERBER RELEASED 04/13/2004

VER.0.50 04/16/2004 RM4\_SIV\_EC\_32/33/36/37/38  
 AND CORRECT C1000 TO SYMBOL WITH POLARITY.

VER.0.51 04/20/2004 CORRECT R417 TO 0 , R522 TO 2M.  
 VER.0.52 04/21/2004 RM4\_SIV\_EC\_39/40/41  
 VER.0.53 04/22/2004 RM4\_SIV\_EC\_42/43  
 VER.0.54 04/23/2004 RM4\_SIV\_EC\_44

## PRE-SIT

VER.0.55 05/18/2004 RM4\_SIT\_EC\_01/02/03/04  
 VER.0.56 05/21/2004 RM4\_SIT\_EC\_05/07/09/13/14/15  
 VER.0.57 05/25/2004 RM4\_SIT\_EC\_16/17/18  
 VER.0.58 05/26/2004 RM4\_SIT\_EC\_ LINKUP/ACTIVITY CHNAGE  
 VER.0.59 06/01/2004 RM4\_SIT\_EC\_19  
 VER.0.60 06/02/2004 RM4\_SIT\_EC\_20/21/23/24/25  
 VER.0.61 06/03/2004 RM4\_SIT\_EC\_26  
 VER.0.62 06/04/2004 RM4\_SIT\_EC\_27/28/29

## PRE-SIT (CONTINUE)

VER.0.63 06/07/2004 RM4\_SIT\_EC\_23/27 CORRECTION/30  
 VER.0.64 06/11/2004 RM4\_SIT\_EC\_32

PRE-SIT GERBER RELEASED ON 06/16/2004

VER.0.65 06/21/2004 RM4\_SIT\_EC\_34  
 VER.0.66 06/30/2004 RM4\_SIT\_EC\_35 (R919 -> NO-ASM, R920->ASM)  
 VER.0.67 07/07/2004 RM4\_SIT\_EC\_36 CHNAGED 12 PARTS  
 VER.0.68 07/20/2004 RM4\_SIT\_EC\_37/38/39/40

## SIT

VER.0.69 07/28/2004 RM4\_SITA\_EC\_02/03/06  
 VER.0.70 07/29/2004 RM4\_SITA\_EC\_07/08  
 VER.0.71 08/03/2004 RM4\_SITA\_EC\_09/10/11  
 VER.0.72 08/06/2004 RM4\_SITA\_EC\_12/13/14/15  
 VER.0.73 08/16/2004 RM4\_SITA\_EC\_16/17/18  
 VER.0.74 08/17/2004 RM4\_SITA\_EC\_19/20/21/22  
 VER.0.75 08/18/2004 RM4\_SITA\_EC\_23  
 VER.0.76 08/20/2004 RM4\_SITA\_EC\_26  
 VER.0.77 08/23/2004 RM4\_SITA\_EC\_27

SIT GERBER RELEASED 08/24/2004.

VER.0.78 08/30/2004 P51 TABLE CORRECTION  
 VER.0.79 09/01/2004 RM4\_SITA\_EC\_28  
 VER.0.80 09/10/2004 RM4\_SITA\_EC\_29/30

## SIT-R

VER.0.81 10/05/2004 RM4\_SITR\_EC\_01/02  
 VER.0.82 10/08/2004 RM4\_SITR\_EC\_03/04  
 VER.0.83 10/19/2004 RM4\_SITR\_EC\_05/06  
 VER.0.84 10/22/2004 RM4\_SITR\_EC\_07/08/10/11  
 VER.0.85 10/25/2004 RM4\_SITR\_EC\_12  
 SIT-R GERBER WAS RELEASED 10/28/2004.  
 VER.0.86 10/29/2004 RM4\_SITR\_EC\_13  
 VER.0.87 11/04/2004 RM4\_SITR\_EC\_15  
 VER.0.88 11/08/2004 RM4\_SITR\_EC\_16/17

## SVT

VER.0.89 11/09/2004 RM4\_SVT\_EC\_01/02/03

SVT GERBER WAS RELEASED 11/12/2004.

VER.0.90 11/15/2004 RM4\_SVT\_EC\_04/05  
 VER.0.90 11/17/2004 ASSIGNED DWG PN=39T0120.

39T0120

DESIGNER	Y.I	NOV/17/04	PART NO.	IBM
CHECKED	Y.Y	NOV/17/04	39T0120	
APPROVED	T.S	NOV/17/04	TITLE ROME-4 SVT(V0.90)	
CLASS	T.S	NOV/17/04	HISTORY	
THIS DOCUMENT IS THE PROPERTY OF IBM ITS USE IS AUTHORIZED ONLY FOR RESPONDING TO A REQUEST FOR QUOTATION OR FOR THE PERFORMANCE OF WORK FOR IBM. ALL QUESTIONS MUST BE REFERRED TO THE IBM PURCHASING DEPARTMENT.				IBM CONFIDENTIAL

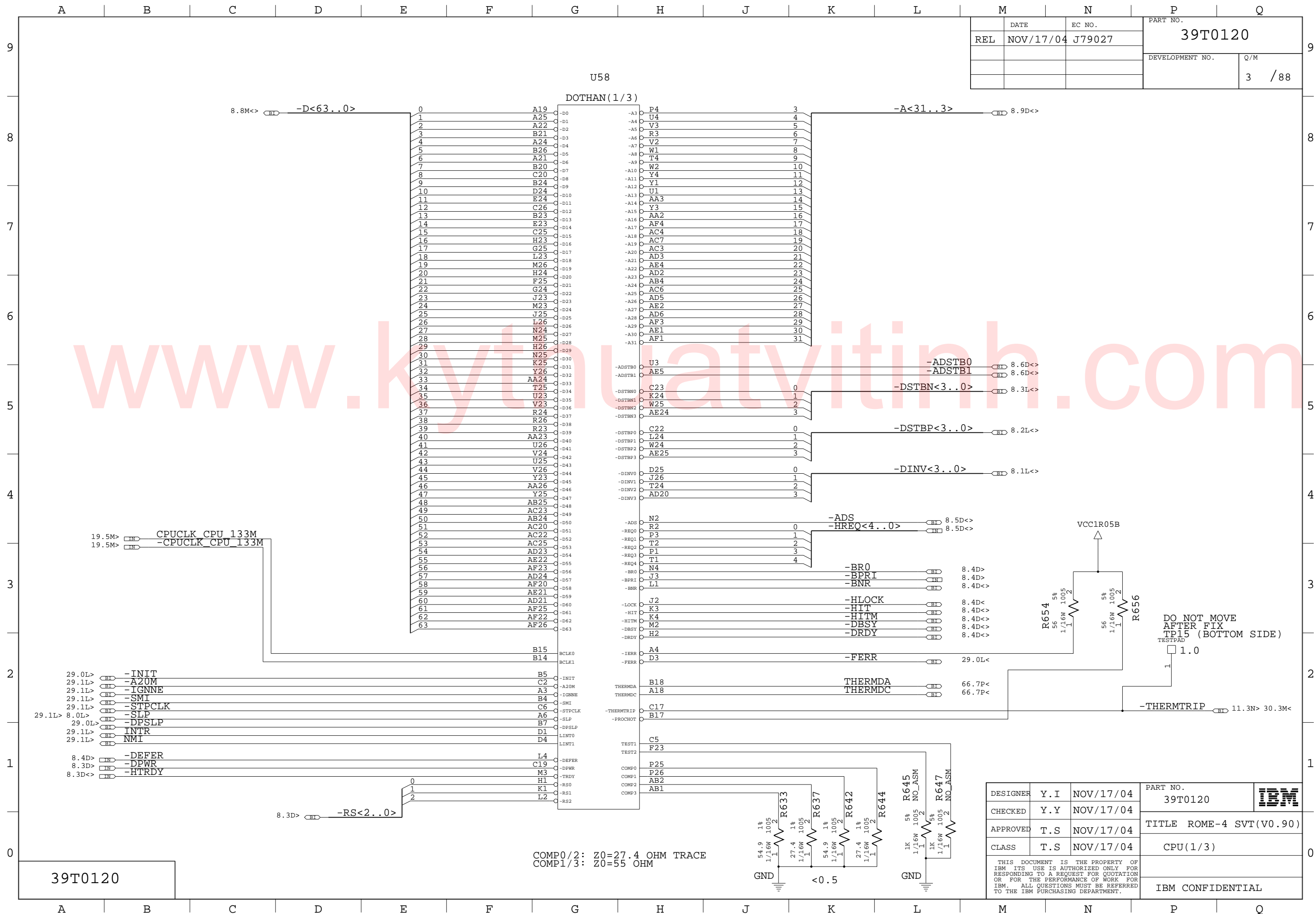

REL	DATE	EC NO.	PART NO.
	NOV/17/04	J79027	39T0120
			DEVELOPMENT NO.
			Q/M
			3 / 88

DESIGNER	Y.I	NOV/17/04	PART NO.	39T0120	IBM
CHECKED	Y.Y	NOV/17/04			
APPROVED	T.S	NOV/17/04	TITLE		ROME-4 SVT(V0.90)
CLASS	T.S	NOV/17/04	CPU(1/3)		
THIS DOCUMENT IS THE PROPERTY OF IBM. ITS USE IS AUTHORIZED ONLY FOR RESPONDING TO A REQUEST FOR QUOTATION OR FOR THE PERFORMANCE OF WORK FOR IBM. ALL QUESTIONS MUST BE REFERRED TO THE IBM PURCHASING DEPARTMENT.					IBM CONFIDENTIAL

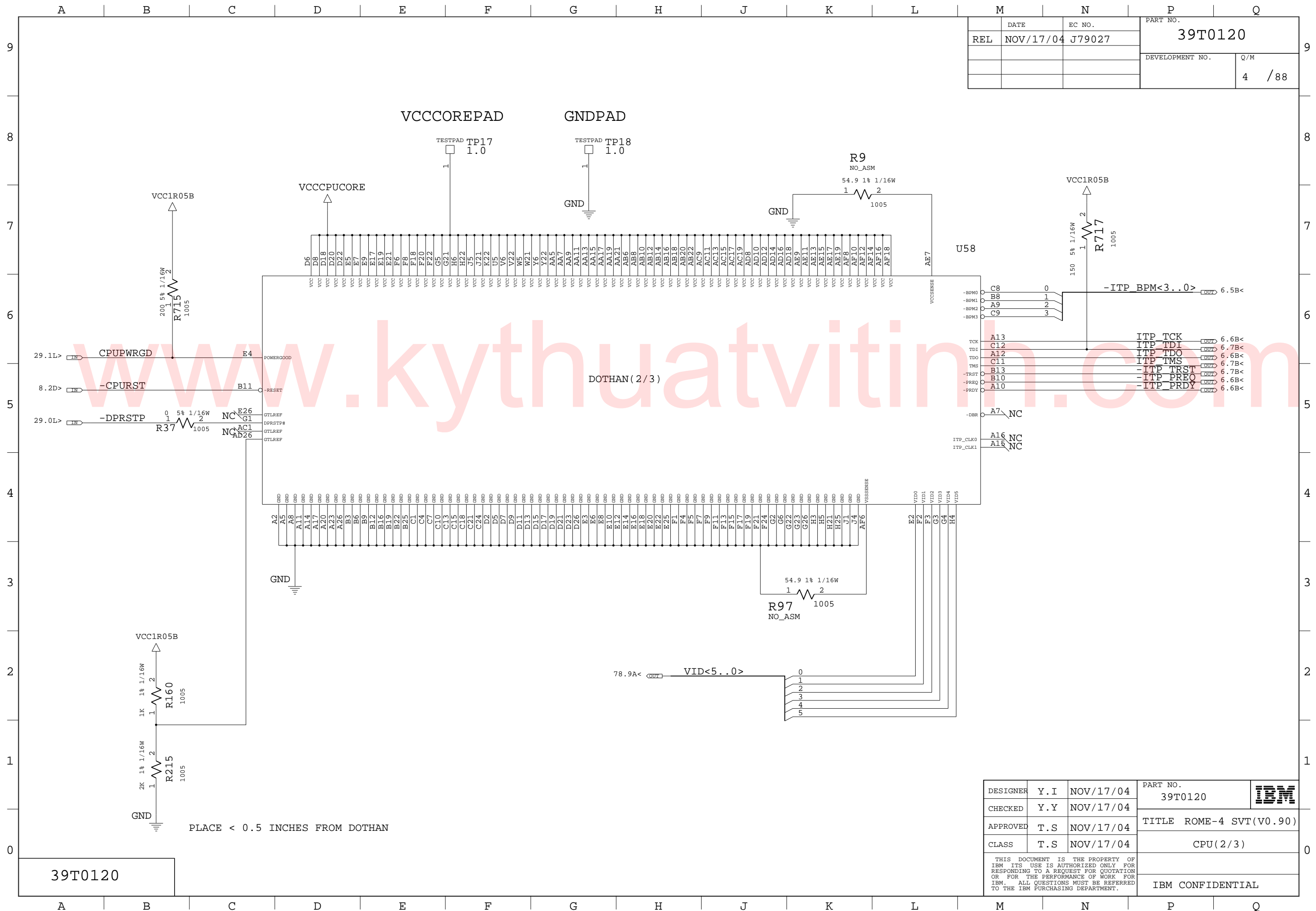

REL	DATE	EC NO.	PART NO.
	NOV/17/04	J79027	39T0120
			DEVELOPMENT NO.
			Q/M
			4 / 88

DESIGNER	Y.I	NOV/17/04	PART NO.	39T0120	
CHECKED	Y.Y	NOV/17/04			
APPROVED	T.S	NOV/17/04	TITLE ROME-4 SVT(V0.90)		
CLASS	T.S	NOV/17/04	CPU(2/3)		
THIS DOCUMENT IS THE PROPERTY OF IBM ITS USE IS AUTHORIZED ONLY FOR RESPONDING TO A REQUEST FOR QUOTATION OR FOR THE PERFORMANCE OF WORK FOR IBM. ALL QUESTIONS MUST BE REFERRED TO THE IBM PURCHASING DEPARTMENT.					IBM CONFIDENTIAL

39T0120

REL	DATE	NOV/17/04	EC NO.	J79027	PART NO.	39T0120	
					DEVELOPMENT NO.	Q/M	5 / 88

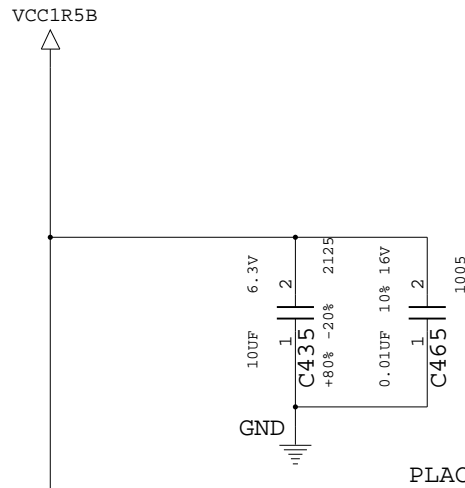
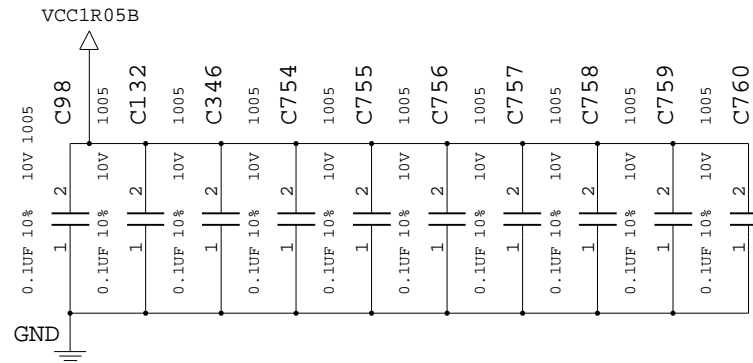
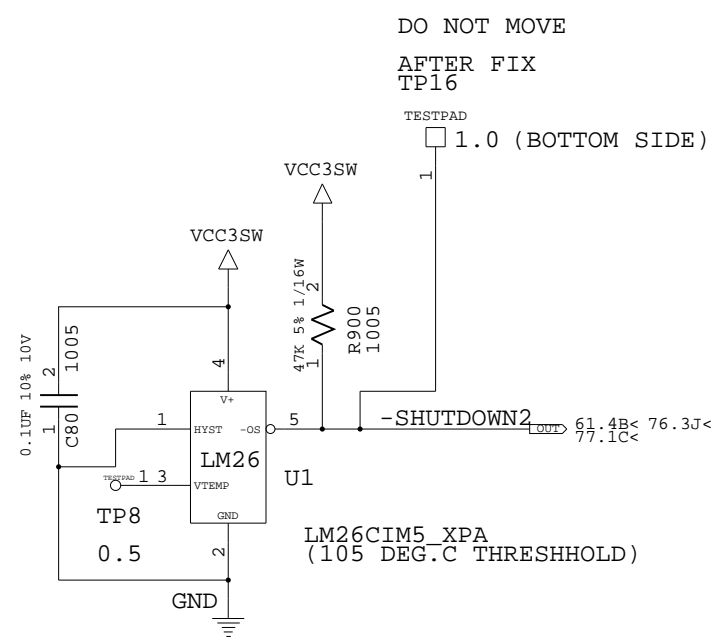

PLACE ONE 10UF AND 0.01UF NEAR VCCA PIN.

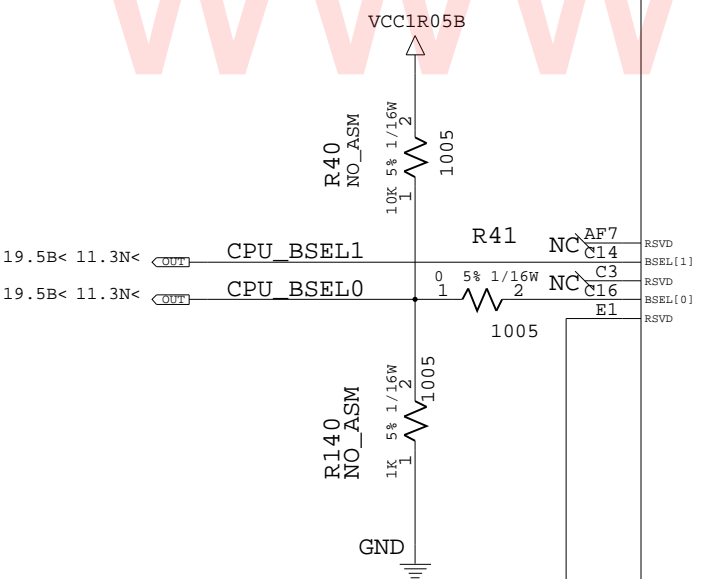
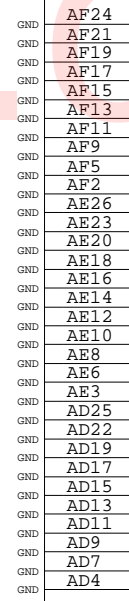
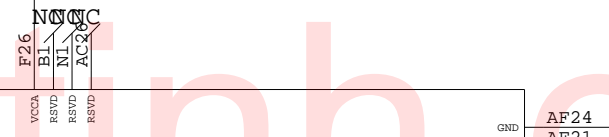
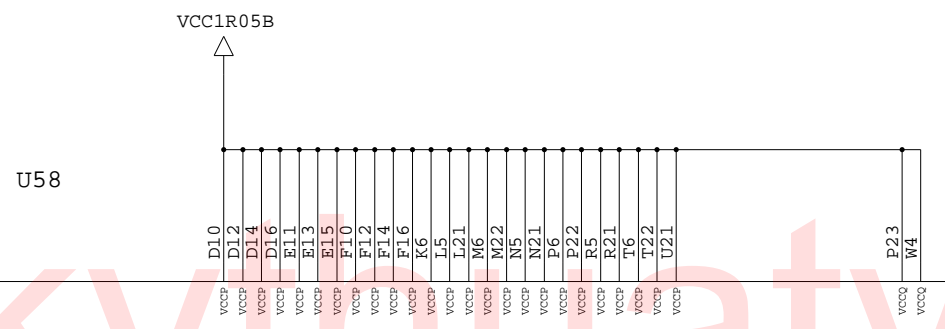

DO THAN (3/3)

	A-STEP		B-STEP	
FSB	533	400	533	400
BSEL1	0	0	0	0
BSEL0	1	0	0	1

	NO_ASM		ASM
R41	NO_ASM	NO_ASM	NO_ASM
R40	ASM	NO_ASM	NO_ASM
R140	NO_ASM	ASM	NO_ASM

PREDRV SIV LOGIC

39T0120

DESIGNER	Y.I	NOV/17/04	PART NO.	39T0120	
CHECKED	Y.Y	NOV/17/04	TITLE	ROME-4 SVT(V0.90)	
APPROVED	T.S	NOV/17/04	CLASS	CPU(3/3)	
THIS DOCUMENT IS THE PROPERTY OF IBM. ITS USE IS AUTHORIZED ONLY FOR RESPONDING TO A REQUEST FOR QUOTATION OR FOR THE PERFORMANCE OF WORK FOR IBM. ALL QUESTIONS MUST BE REFERRED TO THE IBM PURCHASING DEPARTMENT.	IBM CONFIDENTIAL				



	DATE	EC NO.	PART NO.
REL	NOV/17/04	J79027	39T0120
			DEVELOPMENT NO.
			Q/M
			6 / 88

LARGE PTH HOLE

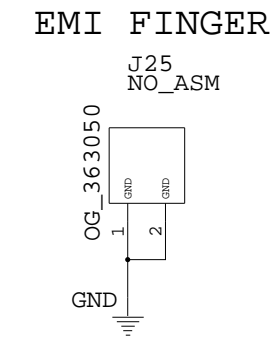
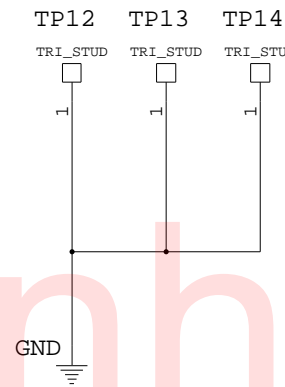
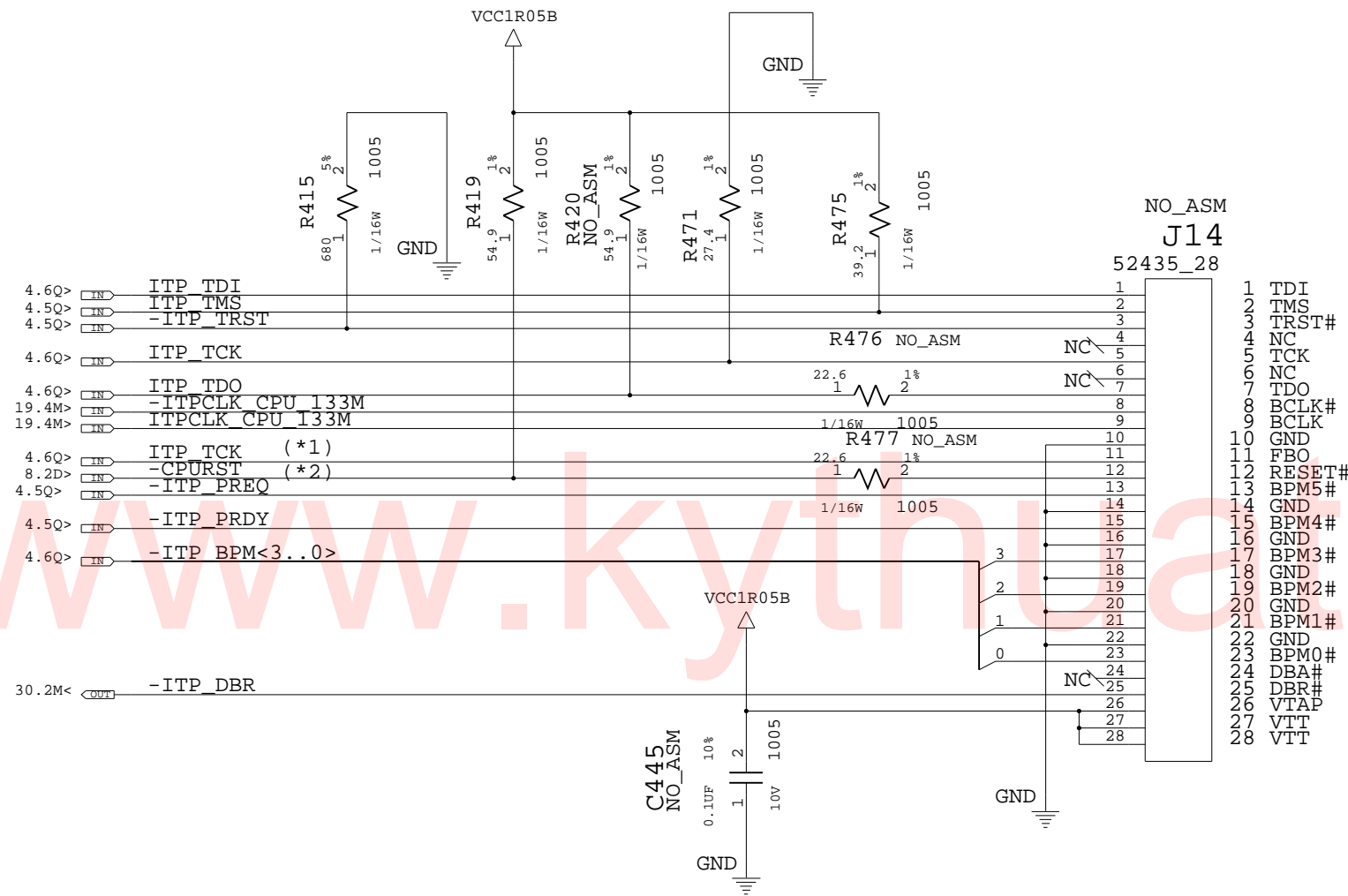

(\*1) TCK SIGNAL IS BRANCHED AT DOTHAN PIN

(\*2) -CPURST SIGNAL IS BRANCHED AT ALVISO PIN

39T0120

DESIGNER	Y.I	NOV/17/04	PART NO.	39T0120	
CHECKED	Y.Y	NOV/17/04			
APPROVED	T.S	NOV/17/04	TITLE ROME-4 SVT(V0.90)		
CLASS	T.S	NOV/17/04	ITP CONN/LARGE PTH HOLE		
THIS DOCUMENT IS THE PROPERTY OF IBM ITS USE IS AUTHORIZED ONLY FOR RESPONDING TO A REQUEST FOR QUOTATION OR FOR THE PERFORMANCE OF WORK FOR IBM. ALL QUESTIONS MUST BE REFERRED TO THE IBM PURCHASING DEPARTMENT.				EMI FINGER	
				IBM CONFIDENTIAL	

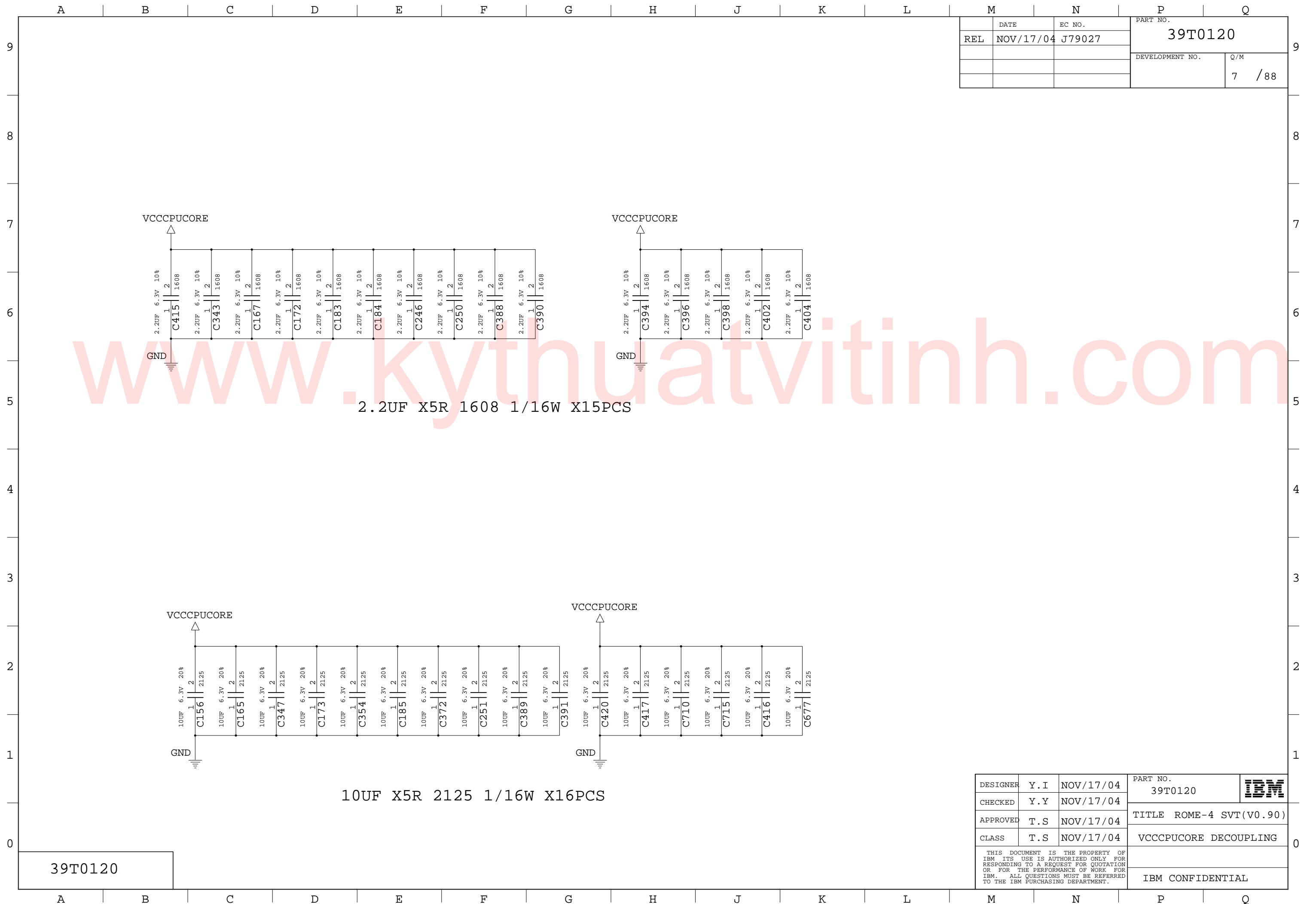

2.2UF X5R 1608 1/16W X15PCS

10UF X5R 2125 1/16W X16PCS

39T0120

	DATE	EC NO.	PART NO.	
REL	NOV/17/04	J79027	39T0120	
			DEVELOPMENT NO.	Q/M
				7 / 88

DESIGNER	Y.I	NOV/17/04	PART NO.	39T0120	
CHECKED	Y.Y	NOV/17/04			
APPROVED	T.S	NOV/17/04	TITLE ROME-4 SVT(V0.90)		
CLASS	T.S	NOV/17/04	VCCCPUCORE DECOUPLING		
THIS DOCUMENT IS THE PROPERTY OF IBM. ITS USE IS AUTHORIZED ONLY FOR RESPONDING TO A REQUEST FOR QUOTATION OR FOR THE PERFORMANCE OF WORK FOR IBM. ALL QUESTIONS MUST BE REFERRED TO THE IBM PURCHASING DEPARTMENT.				IBM CONFIDENTIAL	

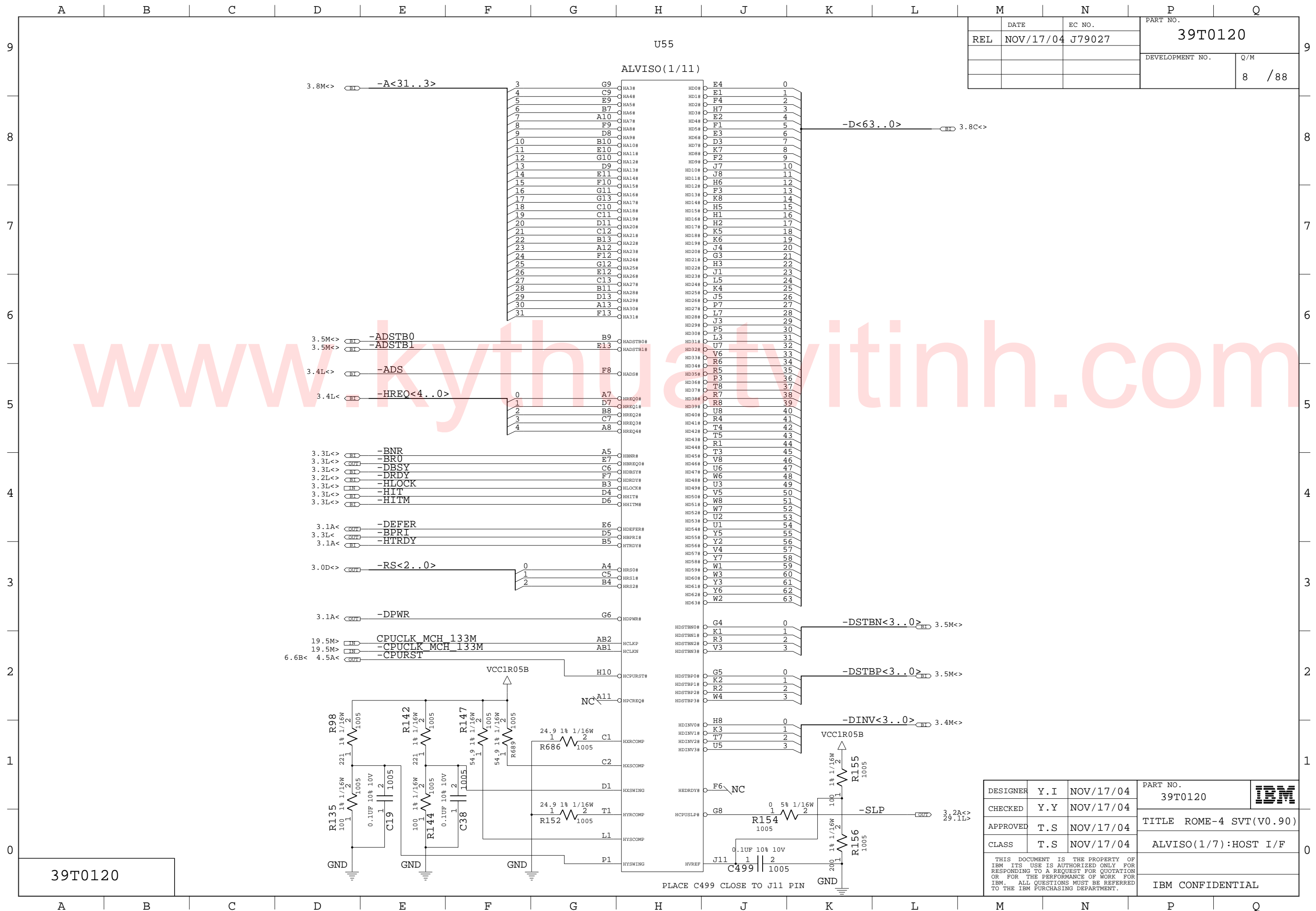

REL	DATE	EC NO.	PART NO.
	NOV/17/04	J79027	39T0120
			DEVELOPMENT NO.
			Q/M
			8 / 88

www.kyathatvinitinh.com

39T0120

DESIGNER	Y.I	NOV/17/04	PART NO.	IBM
CHECKED	Y.Y	NOV/17/04	39T0120	
APPROVED	T.S	NOV/17/04	TITLE	ROME-4 SVT(V0.90)
CLASS	T.S	NOV/17/04		ALVISO(1/7):HOST I/F
THIS DOCUMENT IS THE PROPERTY OF IBM. ITS USE IS AUTHORIZED ONLY FOR RESPONDING TO A REQUEST FOR QUOTATION OR FOR THE PERFORMANCE OF WORK FOR IBM. ALL QUESTIONS MUST BE REFERRED TO THE IBM PURCHASING DEPARTMENT.				IBM CONFIDENTIAL

PLACE C499 CLOSE TO J11 PIN



DATE	NOV/17/04	EC NO.	J79027	PART NO.	39T0120
REL				DEVELOPMENT NO.	9 / 88
				Q/M	

U55

ALVISO (2/11)

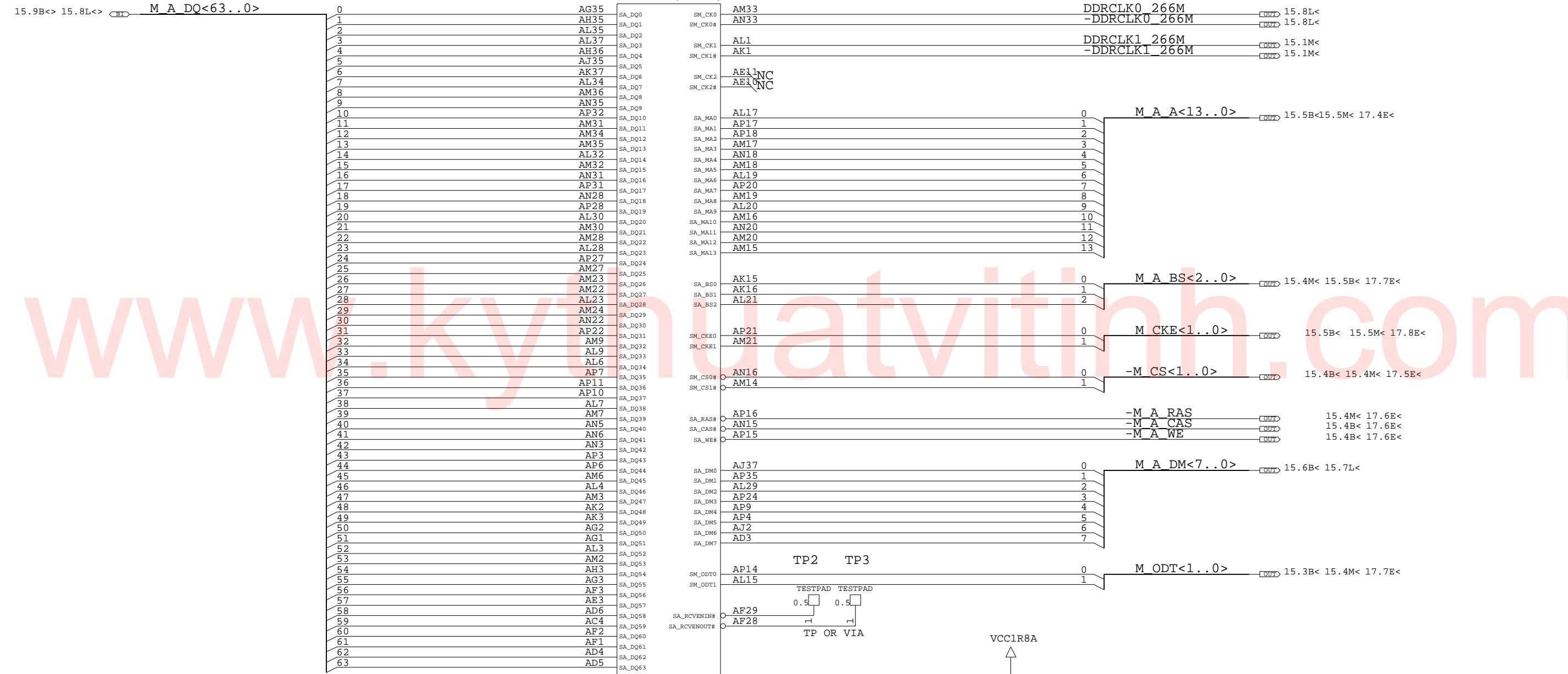

15.7M< 15.9B<> M\_A DQS<7..0>

15.6M< 15.8B<> -M\_A DQS<7..0>

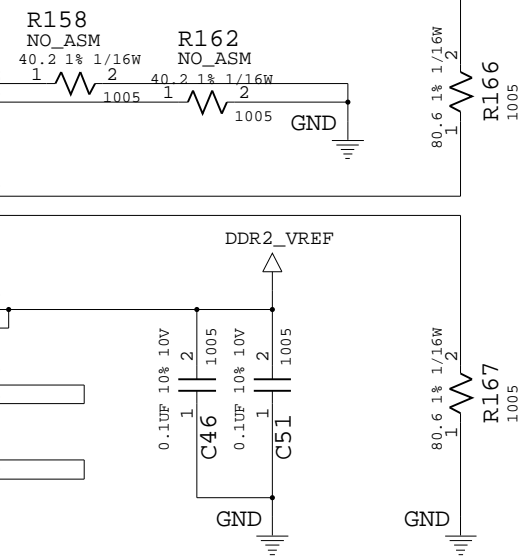

39T0120

DESIGNER	Y.I	NOV/17/04	PART NO.	39T0120	IBM
CHECKED	Y.Y	NOV/17/04	TITLE	ROME-4 SVT(V0.90)	
APPROVED	T.S	NOV/17/04	CLASS	ALVISO(2/7):DDR2-A	
					THIS DOCUMENT IS THE PROPERTY OF IBM ITS USE IS AUTHORIZED ONLY FOR RESPONDING TO A REQUEST FOR QUOTATION OR FOR THE PERFORMANCE OF WORK FOR IBM. ALL QUESTIONS MUST BE REFERRED TO THE IBM PURCHASING DEPARTMENT.
					IBM CONFIDENTIAL

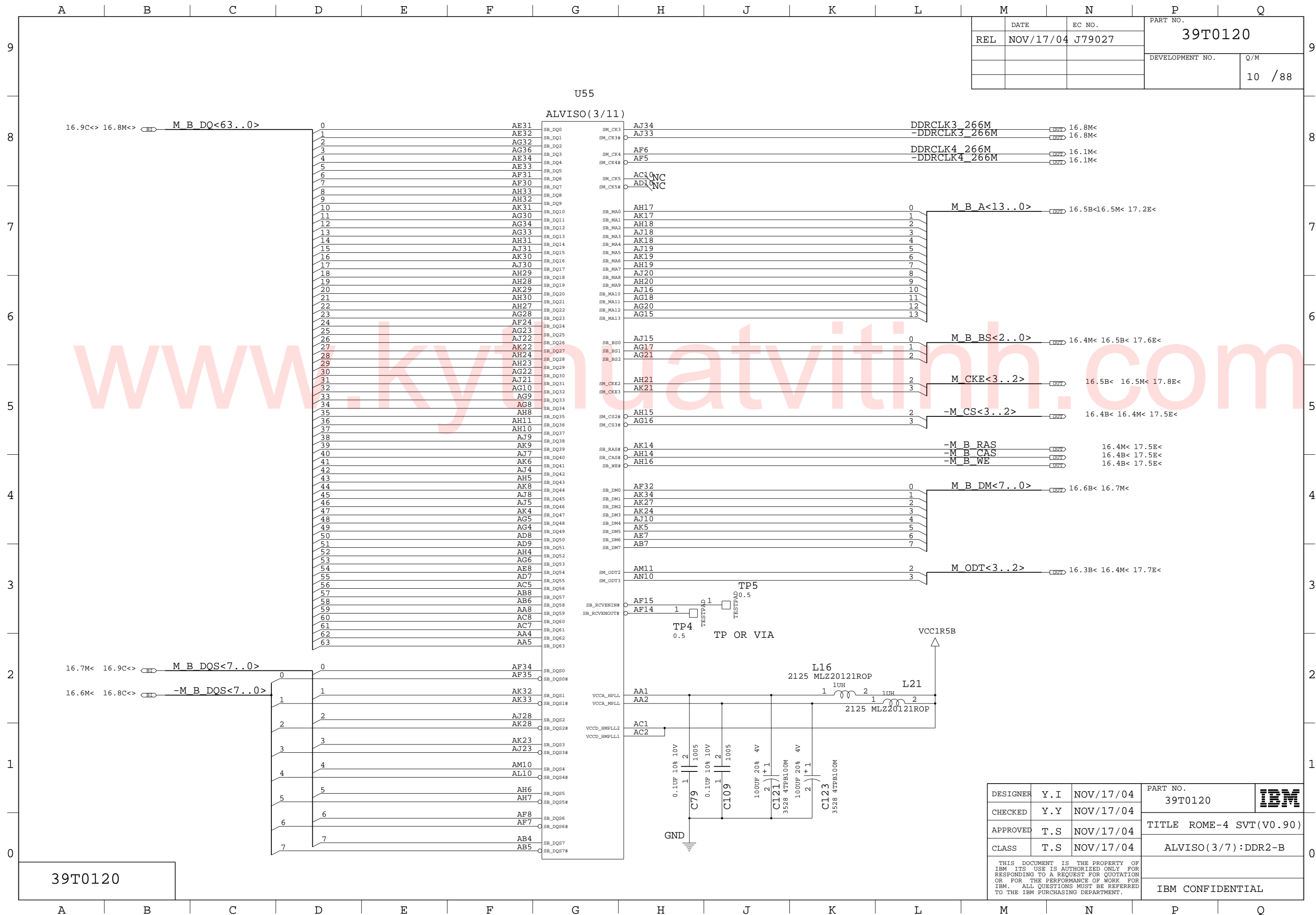

DATE	NOV/17/04	EC NO.	J79027	PART NO.	39T0120
REL				DEVELOPMENT NO.	Q/M
					10 / 88

39T0120

DESIGNER	Y.I	NOV/17/04	PART NO.	39T0120	IBM
CHECKED	Y.Y	NOV/17/04	TITLE	ROME-4 SVT(V0.90)	
APPROVED	T.S	NOV/17/04	CLASS	ALVISO(3/7):DDR2-B	
THIS DOCUMENT IS THE PROPERTY OF IBM. ITS USE IS AUTHORIZED ONLY FOR RESPONDING TO A REQUEST FOR QUOTATION OR FOR THE PERFORMANCE OF WORK FOR IBM. ALL QUESTIONS MUST BE REFERRED TO THE IBM PURCHASING DEPARTMENT.					IBM CONFIDENTIAL

REL	DATE	EC NO.	PART NO.
	NOV/17/04	J79027	39T0120
			DEVELOPMENT NO.
			Q/M
			11 / 88

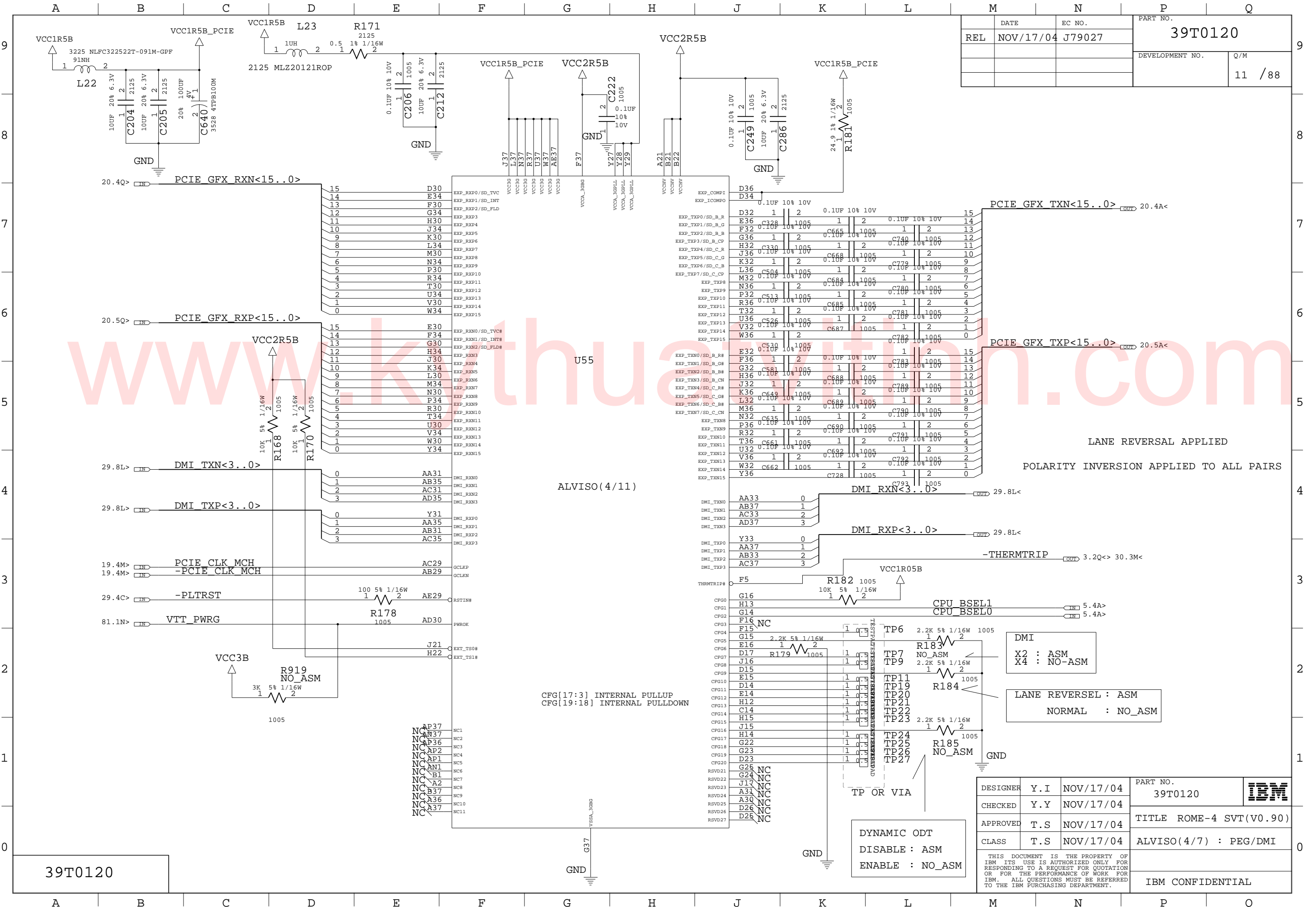

PCIE GFX RXN<15..0> 20.4A<

PCIE GFX TXP<15..0> 20.5A<

LANE REVERSAL APPLIED  
POLARITY INVERSION APPLIED TO ALL PAIRS

DMI  
X2 : ASM  
X4 : NO-ASM

LANE REVERSEL : ASM  
NORMAL : NO\_ASM

DYNAMIC ODT  
DISABLE : ASM  
ENABLE : NO\_ASM

DESIGNER	Y.I	NOV/17/04	PART NO.	39T0120	IBM
CHECKED	Y.Y	NOV/17/04	TITLE		
APPROVED	T.S	NOV/17/04	ALVISO(4/7) : PEG/DMI		
CLASS	T.S	NOV/17/04	THIS DOCUMENT IS THE PROPERTY OF IBM ITS USE IS AUTHORIZED ONLY FOR RESPONDING TO A REQUEST FOR QUOTATION OR FOR THE PERFORMANCE OF WORK FOR IBM. ALL QUESTIONS MUST BE REFERRED TO THE IBM PURCHASING DEPARTMENT.		
			IBM CONFIDENTIAL		

39T0120

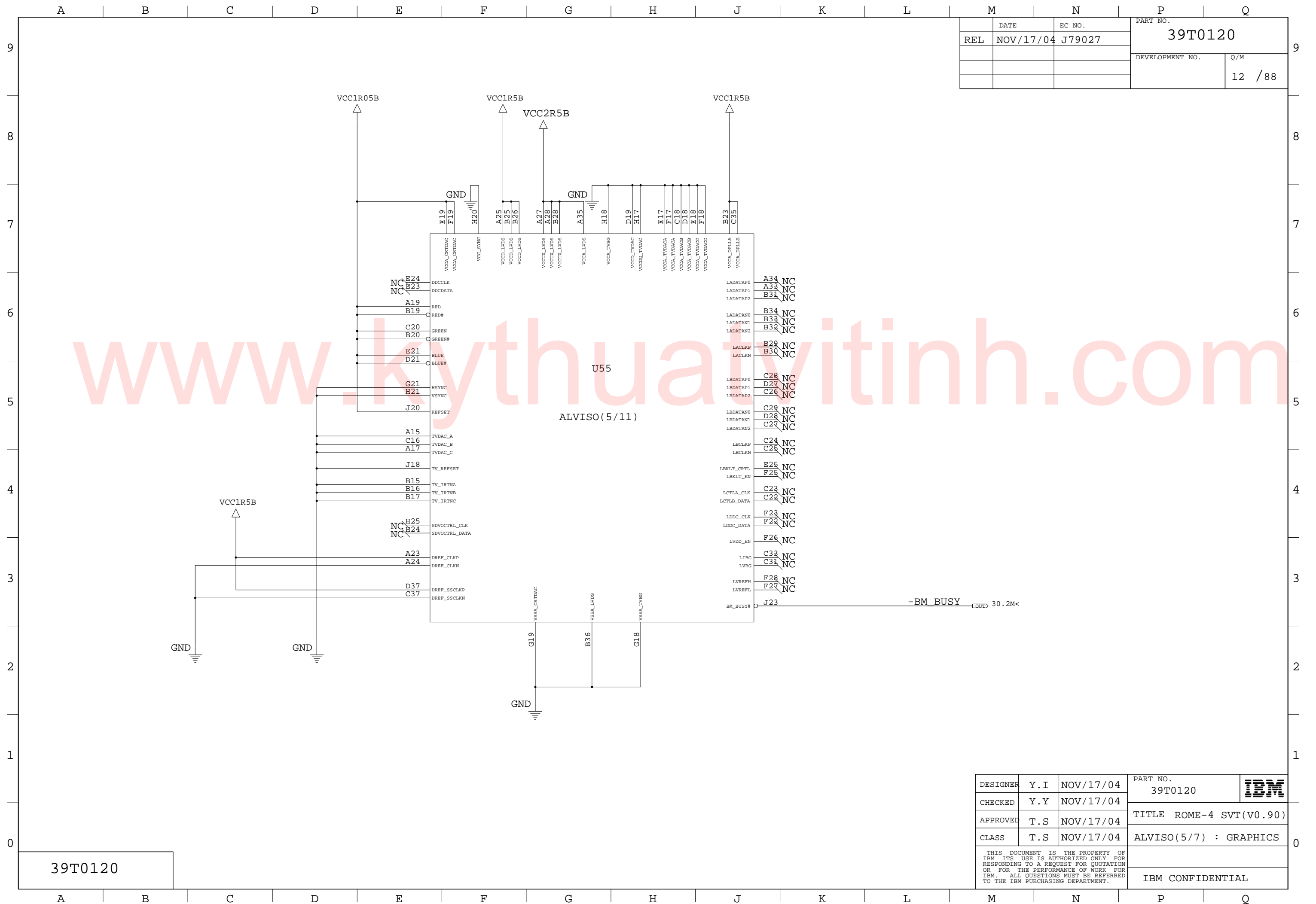

	DATE	EC NO.	PART NO.	
REL	NOV/17/04	J79027	39T0120	
			DEVELOPMENT NO.	Q/M
				12 / 88

39T0120

DESIGNER	Y. I	NOV/17/04	PART NO.	39T0120	
CHECKED	Y. Y	NOV/17/04	TITLE		
APPROVED	T. S	NOV/17/04	CLASS	ALVISO(5/7) : GRAPHICS	
THIS DOCUMENT IS THE PROPERTY OF IBM. ITS USE IS AUTHORIZED ONLY FOR RESPONDING TO A REQUEST FOR QUOTATION OR FOR THE PERFORMANCE OF WORK FOR IBM. ALL QUESTIONS MUST BE REFERRED TO THE IBM PURCHASING DEPARTMENT.					IBM CONFIDENTIAL

REL	DATE	EC NO.	PART NO.
	NOV/17/04	J79027	39T0120
			DEVELOPMENT NO.
			Q/M
			13 / 88

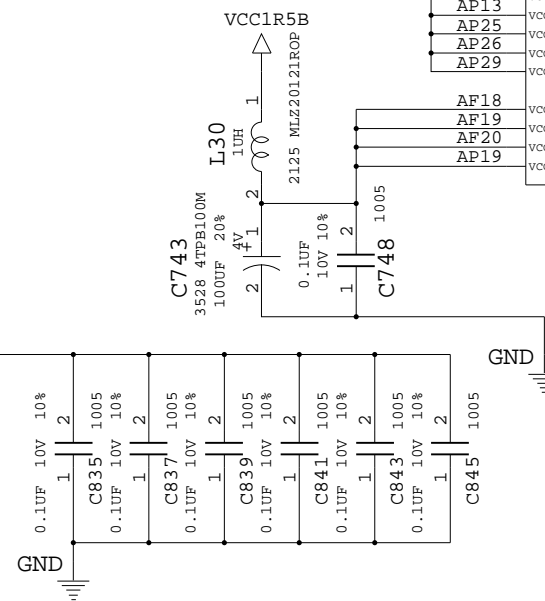
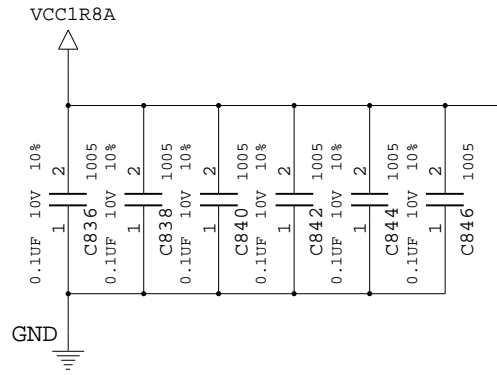
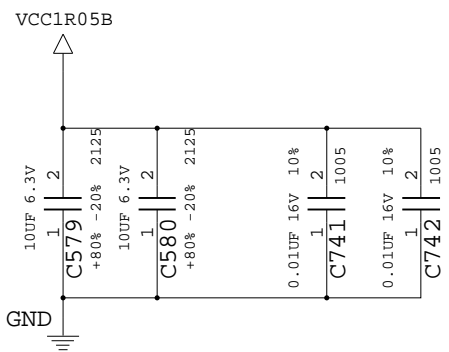
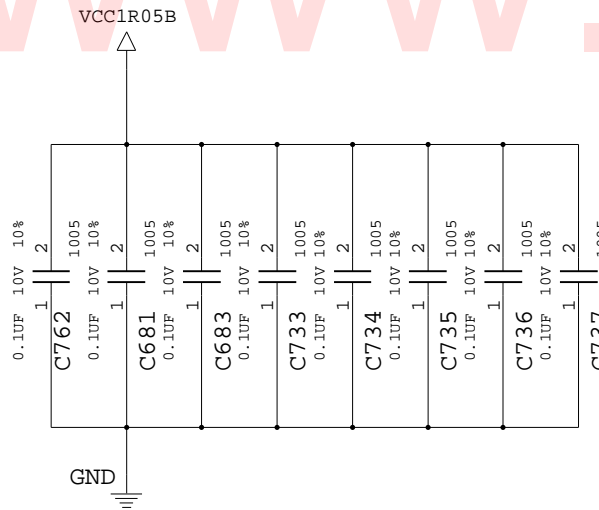
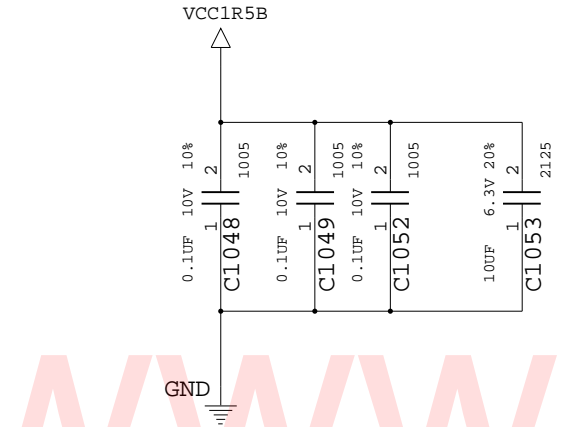
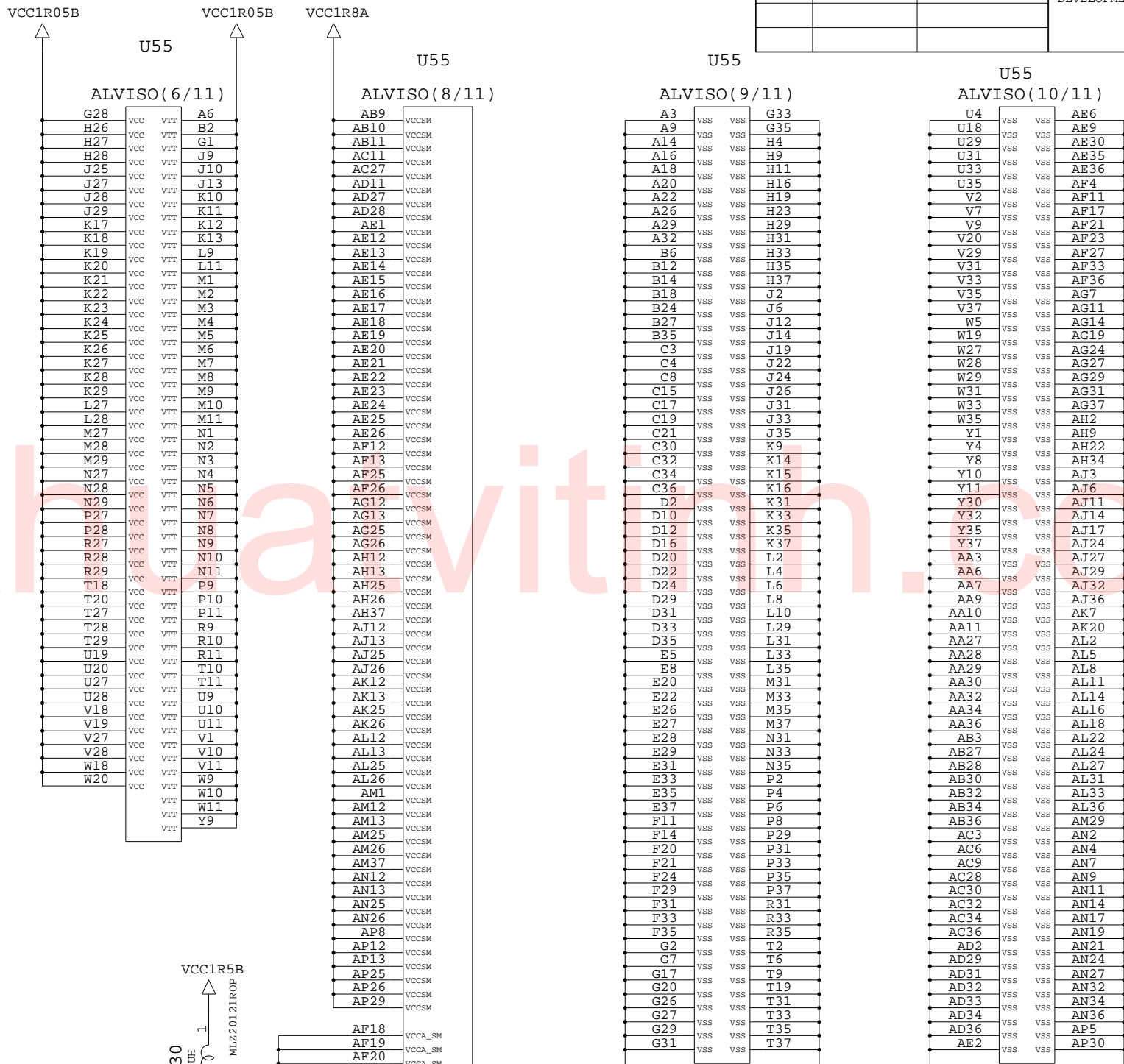

PLACE NEAR VCCGA AND VCCHA.  
39T0120

DESIGNER	Y.I	NOV/17/04	PART NO.	39T0120	IBM
CHECKED	Y.Y	NOV/17/04			
APPROVED	T.S	NOV/17/04	TITLE ROME-4 SVT(V0.90)		
CLASS	T.S	NOV/17/04	ALVISO(6/7) : VCC/GND		
THIS DOCUMENT IS THE PROPERTY OF IBM. ITS USE IS AUTHORIZED ONLY FOR RESPONDING TO A REQUEST FOR QUOTATION OR FOR THE PERFORMANCE OF WORK FOR IBM. ALL QUESTIONS MUST BE REFERRED TO THE IBM PURCHASING DEPARTMENT.					IBM CONFIDENTIAL



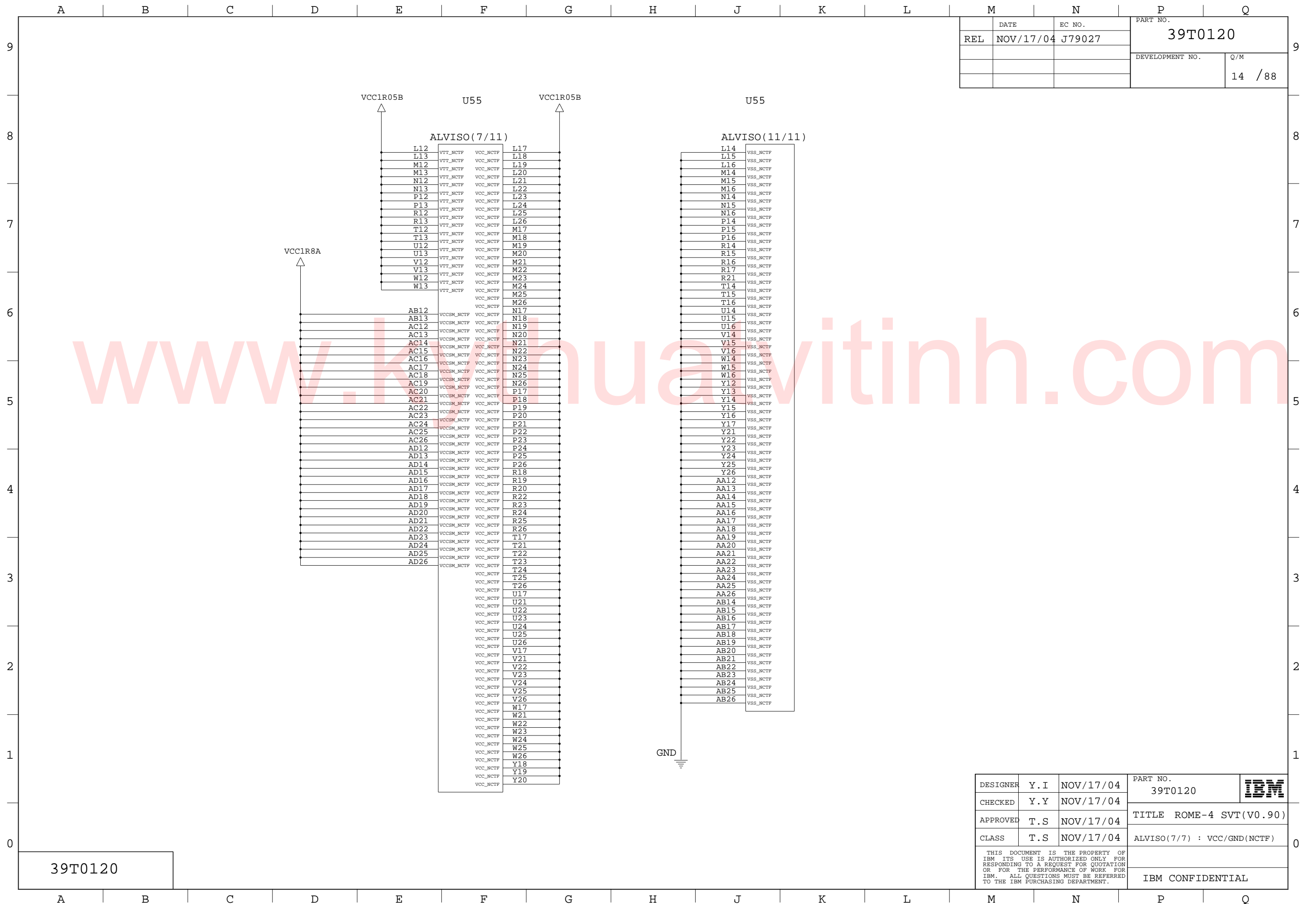

	DATE	EC NO.	PART NO.	
REL	NOV/17/04	J79027	39T0120	
			DEVELOPMENT NO.	Q/M
				14 / 88

www.khuavinh.com

39T0120

DESIGNER	Y. I	NOV/17/04	PART NO.	39T0120	
CHECKED	Y. Y	NOV/17/04			
APPROVED	T. S	NOV/17/04	TITLE ROME-4 SVT(V0.90)		
CLASS	T. S	NOV/17/04	ALVISO(7/7) : VCC/GND(NCTF)		
THIS DOCUMENT IS THE PROPERTY OF IBM ITS USE IS AUTHORIZED ONLY FOR RESPONDING TO A REQUEST FOR QUOTATION OR FOR THE PERFORMANCE OF WORK FOR IBM. ALL QUESTIONS MUST BE REFERRED TO THE IBM PURCHASING DEPARTMENT.					IBM CONFIDENTIAL



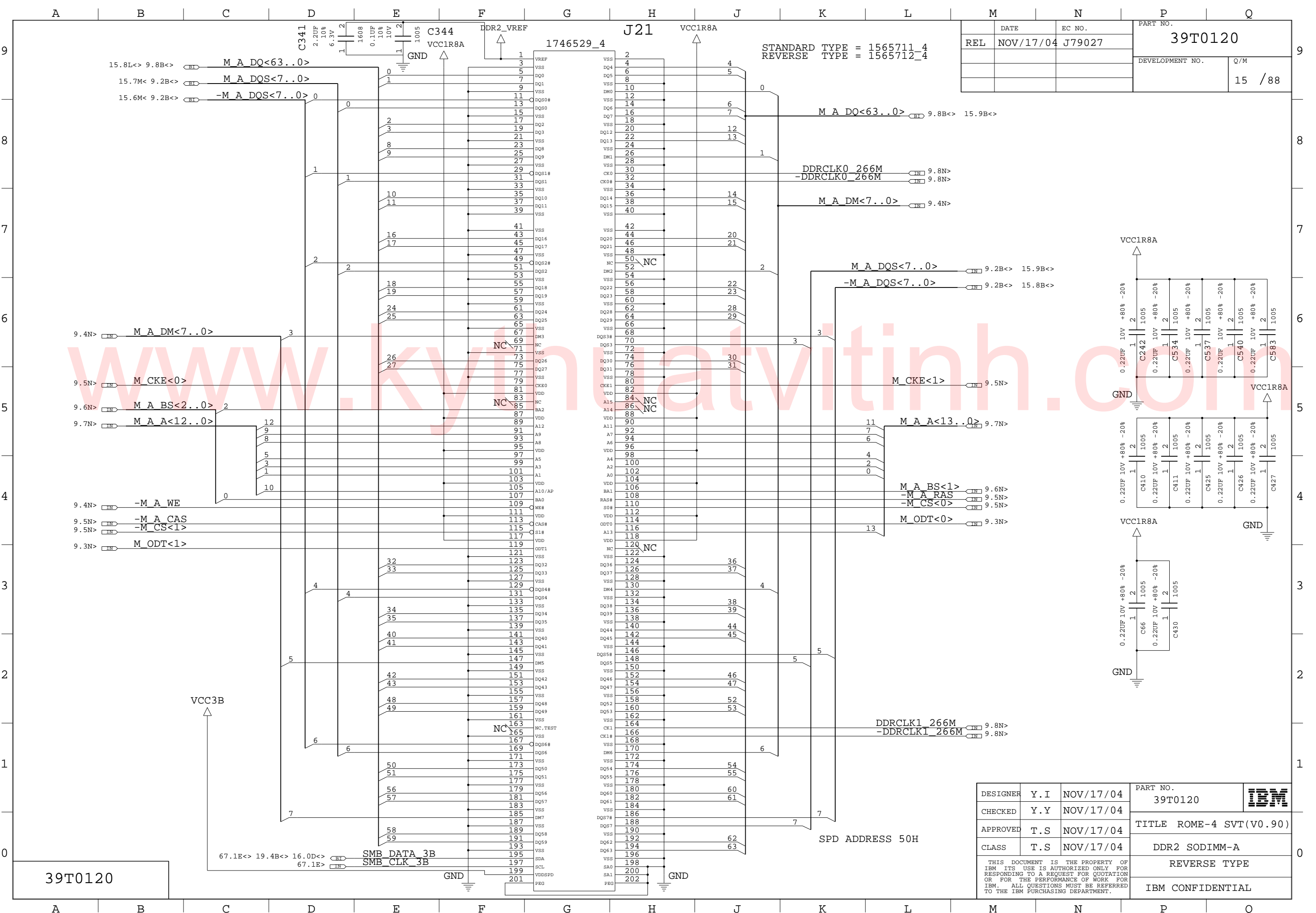

DATE	EC NO.	PART NO.
NOV/17/04	J79027	39T0120
DEVELOPMENT NO.		Q/M
		15 / 88

STANDARD TYPE = 1565711\_4  
 REVERSE TYPE = 1565712\_4

DESIGNER	Y.I	NOV/17/04	PART NO.	39T0120	IBM
CHECKED	Y.Y	NOV/17/04			
APPROVED	T.S	NOV/17/04	TITLE ROME-4 SVT(V0.90)		
CLASS	T.S	NOV/17/04	DDR2 SODIMM-A		
THIS DOCUMENT IS THE PROPERTY OF IBM ITS USE IS AUTHORIZED ONLY FOR RESPONDING TO A REQUEST FOR QUOTATION OR FOR THE PERFORMANCE OF WORK FOR IBM. ALL QUESTIONS MUST BE REFERRED TO THE IBM PURCHASING DEPARTMENT.				REVERSE TYPE	
				IBM CONFIDENTIAL	

39T0120

SPD ADDRESS 50H

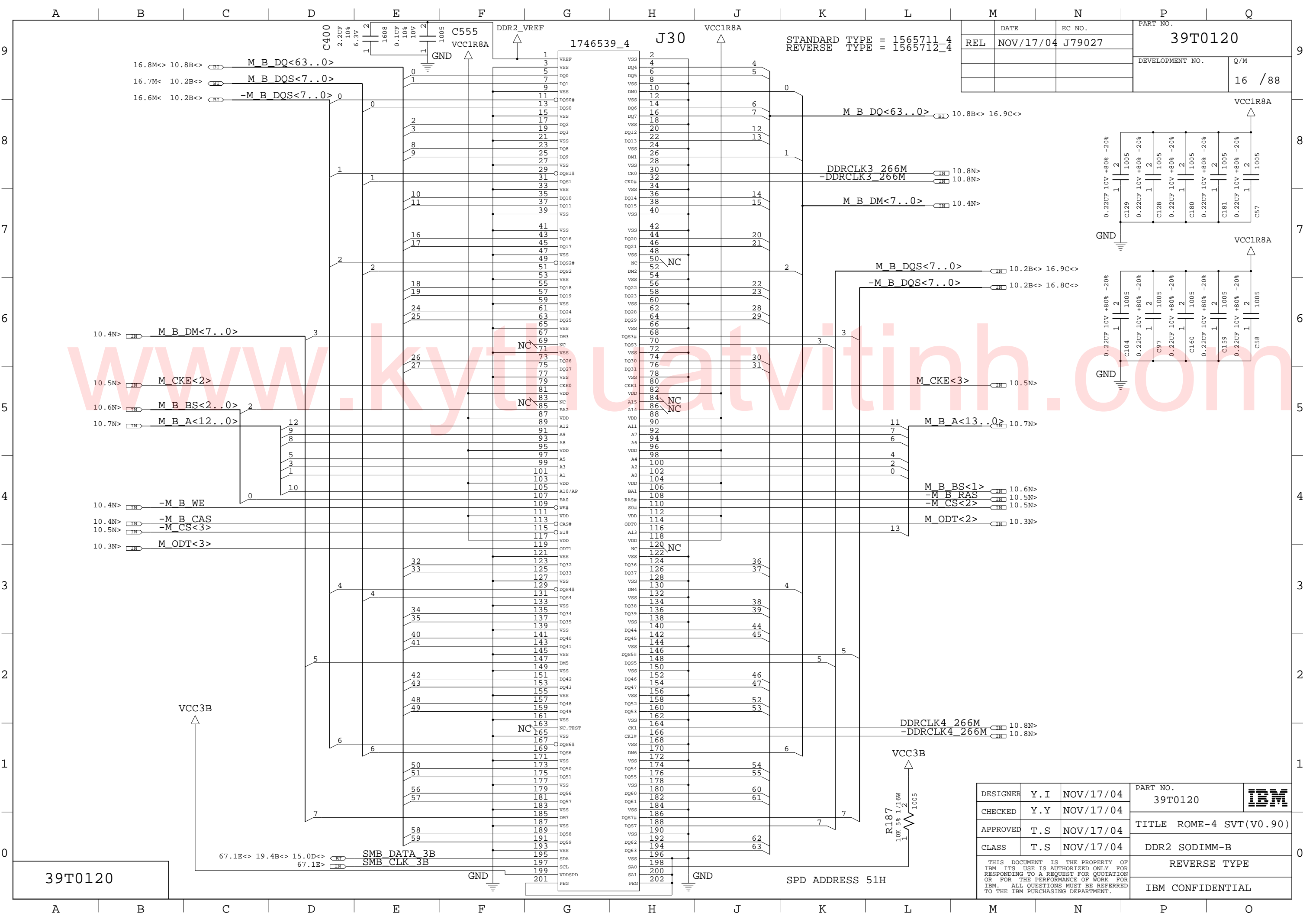

DATE	NOV/17/04	EC NO.	J79027	PART NO.	39T0120
REL				DEVELOPMENT NO.	16 / 88

DESIGNER	Y.I	NOV/17/04	PART NO.	39T0120	
CHECKED	Y.Y	NOV/17/04	TITLE	ROME-4 SVT(V0.90)	
APPROVED	T.S	NOV/17/04	CLASS	DDR2 SODIMM-B	
				REVERSE TYPE	
THIS DOCUMENT IS THE PROPERTY OF IBM ITS USE IS AUTHORIZED ONLY FOR RESPONDING TO A REQUEST FOR QUOTATION OR FOR THE PERFORMANCE OF WORK FOR IBM. ALL QUESTIONS MUST BE REFERRED TO THE IBM PURCHASING DEPARTMENT.					IBM CONFIDENTIAL

39T0120

SPD ADDRESS 51H

REL	DATE	EC NO.	PART NO.	
	NOV/17/04	J79027	39T0120	
			DEVELOPMENT NO.	Q/M
				17 / 88

9  
8  
7  
6  
5  
4  
3  
2  
1  
0

9  
8  
7  
6  
5  
4  
3  
2  
1  
0

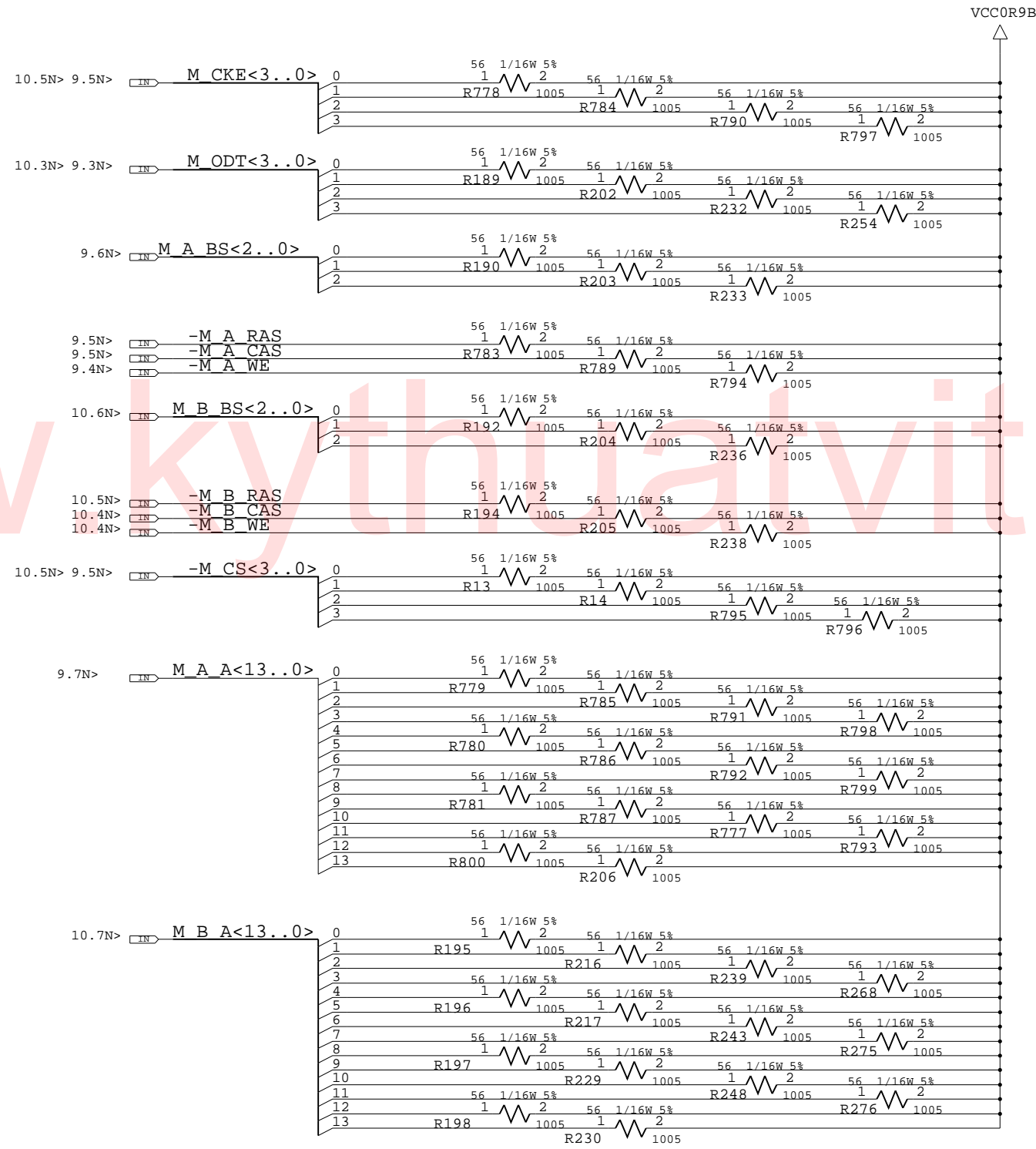

39T0120

DESIGNER	Y.I	NOV/17/04	PART NO.	39T0120	<b>IBM</b>
CHECKED	Y.Y	NOV/17/04			
APPROVED	T.S	NOV/17/04	TITLE ROME-4 SVT(V0.90)		
CLASS	T.S	NOV/17/04	DDR-2 TERMINATION		
THIS DOCUMENT IS THE PROPERTY OF IBM. ITS USE IS AUTHORIZED ONLY FOR RESPONDING TO A REQUEST FOR QUOTATION OR FOR THE PERFORMANCE OF WORK FOR IBM. ALL QUESTIONS MUST BE REFERRED TO THE IBM PURCHASING DEPARTMENT.				IBM CONFIDENTIAL	

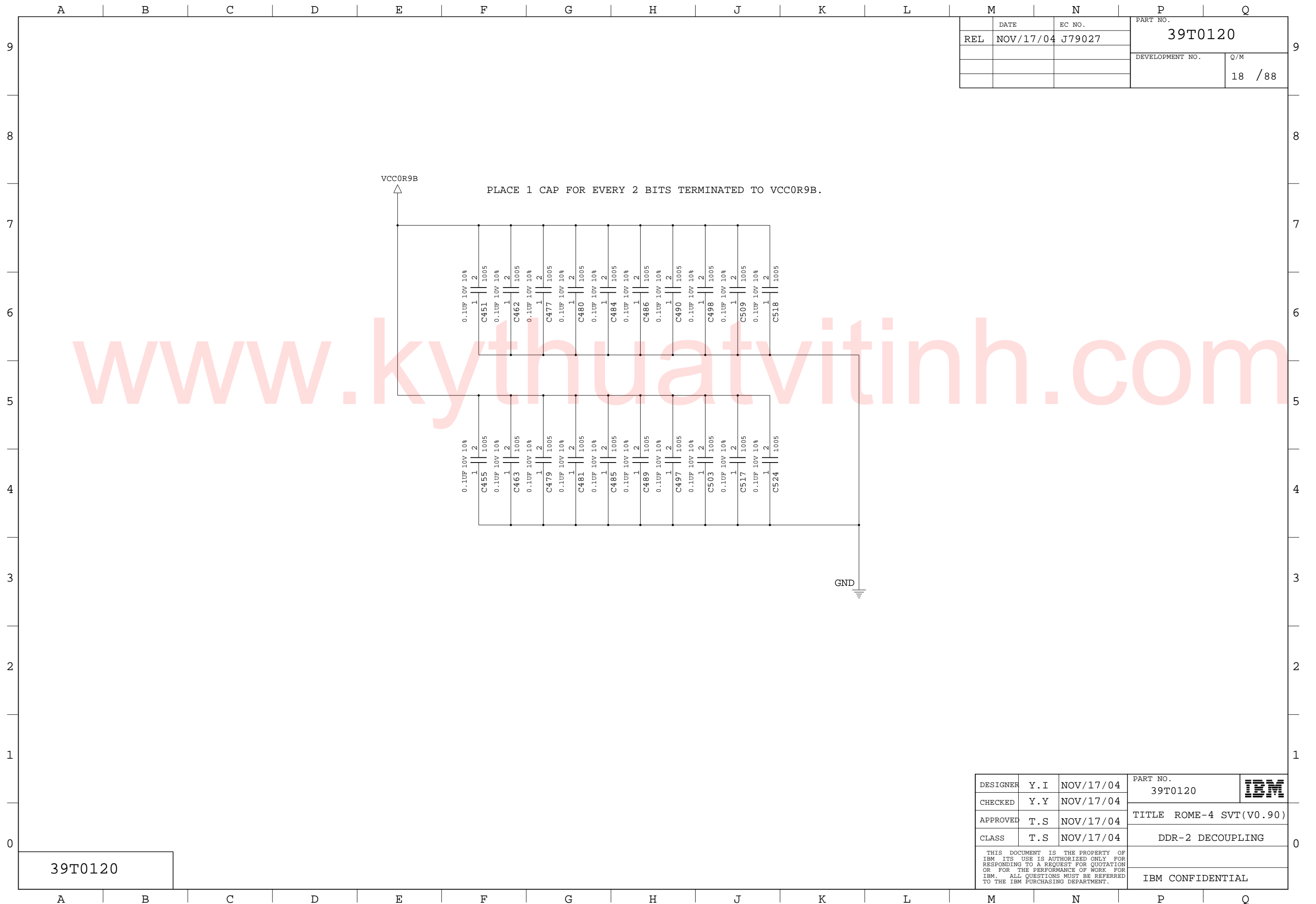

	DATE	EC NO.	PART NO.	
REL	NOV/17/04	J79027	39T0120	
			DEVELOPMENT NO.	Q/M
				18 / 88

39T0120

DESIGNER	Y.I	NOV/17/04	PART NO.	IBM
CHECKED	Y.Y	NOV/17/04	39T0120	
APPROVED	T.S	NOV/17/04	TITLE ROME-4 SVT(V0.90)	
CLASS	T.S	NOV/17/04	DDR-2 DECOUPLING	
THIS DOCUMENT IS THE PROPERTY OF IBM. ITS USE IS AUTHORIZED ONLY FOR RESPONDING TO A REQUEST FOR QUOTATION OR FOR THE PERFORMANCE OF WORK FOR IBM. ALL QUESTIONS MUST BE REFERRED TO THE IBM PURCHASING DEPARTMENT.				IBM CONFIDENTIAL

DATE	EC NO.	PART NO.
NOV/17/04	J79027	39T0120
DEVELOPMENT NO.		Q/M
		19 / 88

VCC3B  
PLACE AT LEAST 1 CAP FOR EACH VDD PINS

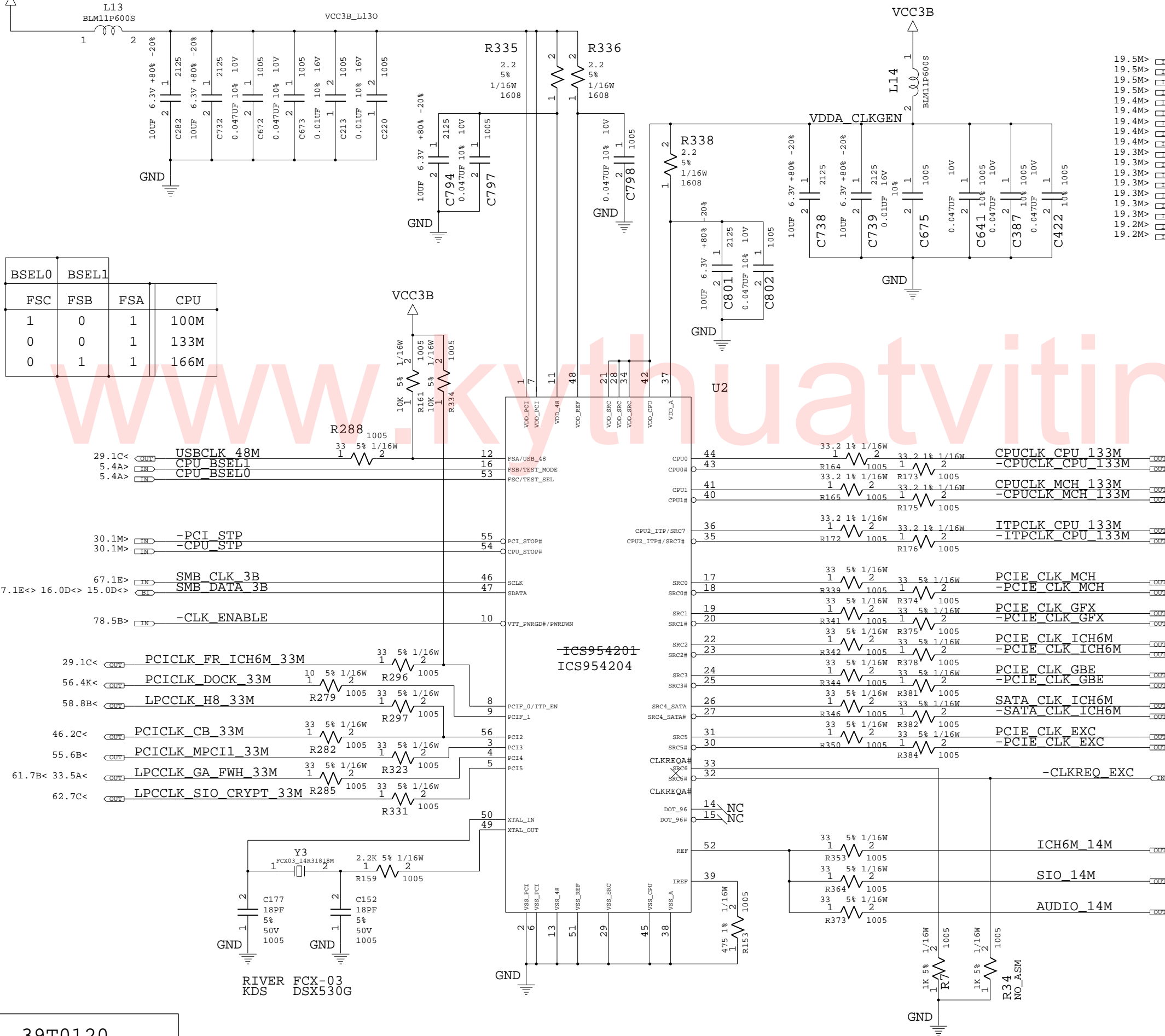

BSEL0	BSEL1	FSC	FSB	FSA	CPU
1	0	1			100M
0	0	1			133M
0	1	1			166M

19.5M	IN	CPUCCLK CPU 133M	49.9 1% 1/16W	1	2	49.9 1% 1/16W	1	2	R186	1005
19.5M	IN	-CPUCCLK CPU 133M	49.9 1% 1/16W	1	2	49.9 1% 1/16W	1	2	R186	1005
19.5M	IN	CPUCCLK MCH 133M	49.9 1% 1/16W	1	2	49.9 1% 1/16W	1	2	R469	1005
19.5M	IN	-CPUCCLK MCH 133M	49.9 1% 1/16W	1	2	49.9 1% 1/16W	1	2	R469	1005
19.4M	IN	ITPCLK CPU 133M	49.9 1% 1/16W	1	2	49.9 1% 1/16W	1	2	R510	1005
19.4M	IN	-ITPCLK CPU 133M	49.9 1% 1/16W	1	2	49.9 1% 1/16W	1	2	R510	1005
19.4M	IN	PCIE CLK MCH	49.9 1% 1/16W	1	2	49.9 1% 1/16W	1	2	R393	1005
19.4M	IN	-PCIE CLK MCH	49.9 1% 1/16W	1	2	49.9 1% 1/16W	1	2	R393	1005
19.4M	IN	PCIE CLK GFX	49.9 1% 1/16W	1	2	49.9 1% 1/16W	1	2	R478	1005
19.4M	IN	-PCIE CLK GFX	49.9 1% 1/16W	1	2	49.9 1% 1/16W	1	2	R478	1005
19.3M	IN	PCIE CLK ICH6M	49.9 1% 1/16W	1	2	49.9 1% 1/16W	1	2	R480	1005
19.3M	IN	-PCIE CLK ICH6M	49.9 1% 1/16W	1	2	49.9 1% 1/16W	1	2	R480	1005
19.3M	IN	PCIE CLK GBE	49.9 1% 1/16W	1	2	49.9 1% 1/16W	1	2	R411	1005
19.3M	IN	-PCIE CLK GBE	49.9 1% 1/16W	1	2	49.9 1% 1/16W	1	2	R411	1005
19.3M	IN	SATA CLK ICH6M	49.9 1% 1/16W	1	2	49.9 1% 1/16W	1	2	R485	1005
19.3M	IN	-SATA CLK ICH6M	49.9 1% 1/16W	1	2	49.9 1% 1/16W	1	2	R485	1005
19.2M	IN	PCIE CLK EXC	49.9 1% 1/16W	1	2	49.9 1% 1/16W	1	2	R487	1005
19.2M	IN	-PCIE CLK EXC	49.9 1% 1/16W	1	2	49.9 1% 1/16W	1	2	R487	1005

39T0120

DESIGNER	Y.I	NOV/17/04	PART NO.	39T0120	IBM
CHECKED	Y.Y	NOV/17/04	TITLE ROME-4 SVT(V0.90)		
APPROVED	T.S	NOV/17/04	CLASS CLOCK GEN(CK410M)		
THIS DOCUMENT IS THE PROPERTY OF IBM ITS USE IS AUTHORIZED ONLY FOR RESPONDING TO A REQUEST FOR QUOTATION OR FOR THE PERFORMANCE OF WORK FOR IBM. ALL QUESTIONS MUST BE REFERRED TO THE IBM PURCHASING DEPARTMENT.					IBM CONFIDENTIAL

DATE	NOV/17/04	EC NO.	J79027	PART NO.	39T0120
REL	NOV/17/04			DEVELOPMENT NO.	Q/M
					20 / 88

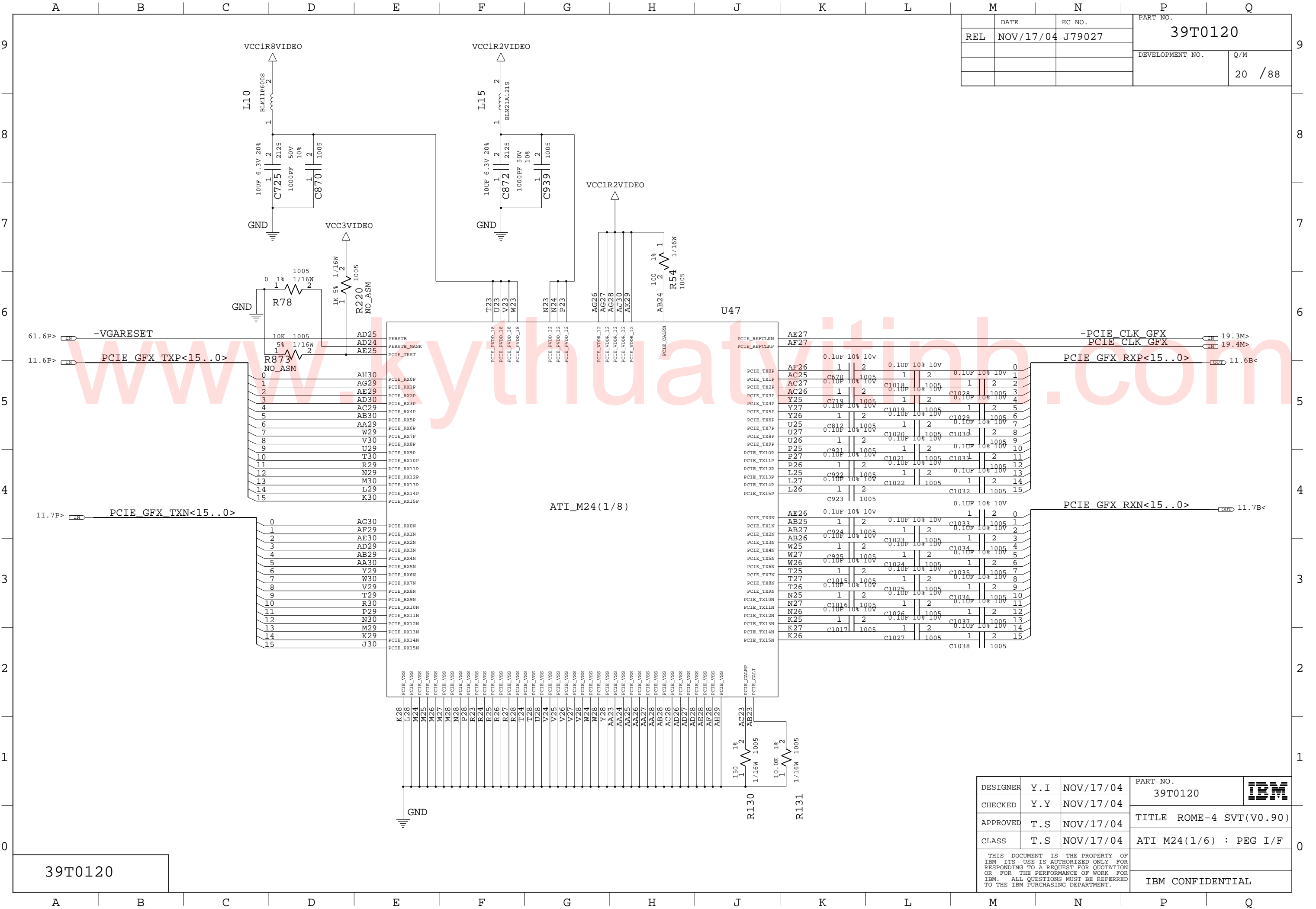

39T0120

DESIGNER	Y.I	NOV/17/04	PART NO.	39T0120	
CHECKED	Y.Y	NOV/17/04			
APPROVED	T.S	NOV/17/04	TITLE ROME-4 SVT(V0.90)		
CLASS	T.S	NOV/17/04	ATI M24(1/6) : PEG I/F		
THIS DOCUMENT IS THE PROPERTY OF IBM ITS USE IS AUTHORIZED ONLY FOR RESPONDING TO A REQUEST FOR QUOTATION OR FOR THE PERFORMANCE OF WORK FOR IBM. ALL QUESTIONS MUST BE REFERRED TO THE IBM PURCHASING DEPARTMENT.					IBM CONFIDENTIAL



DATE	NOV/17/04	EC NO.	J79027	PART NO.	39T0120
REL				DEVELOPMENT NO.	21 / 88
				Q/M	

U47  
ATI\_M24(2/8)

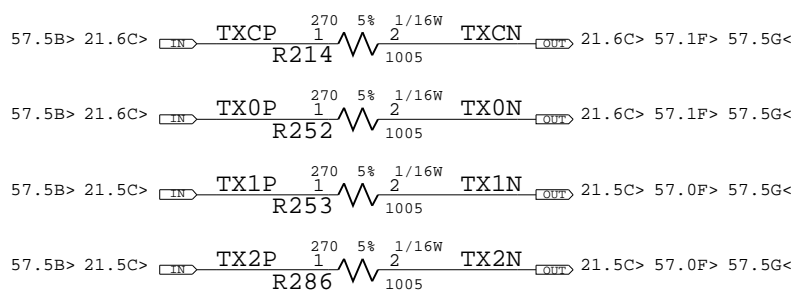
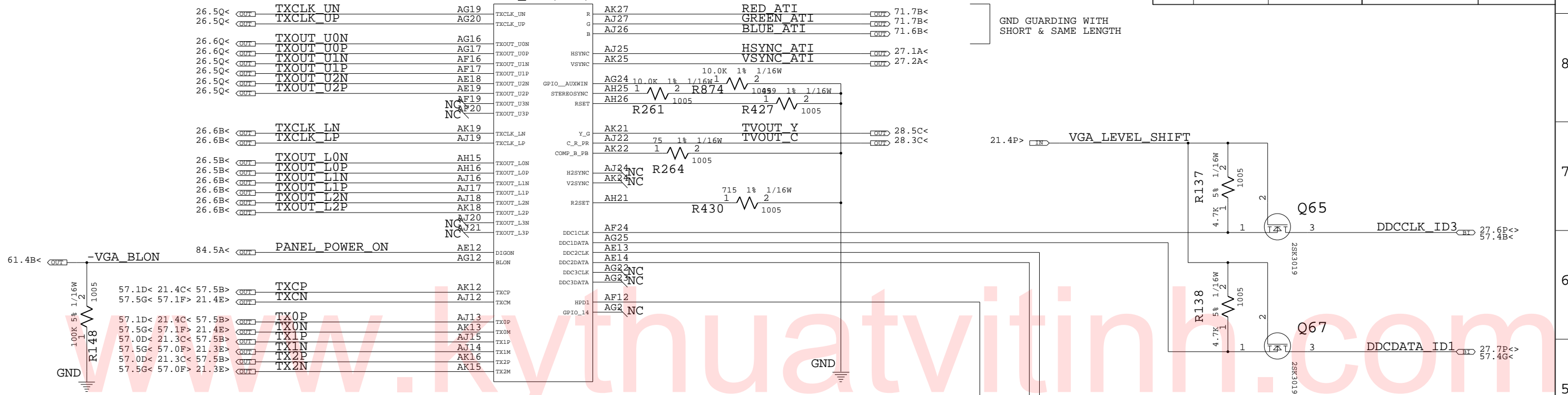

ATI M22/M24

	M22	M24
R214		270 5% 1005(0402)
R252	180 5% 1005(0402)	
R253		270 5% 1005(0402)
R286		270 5% 1005(0402)

LOGIC

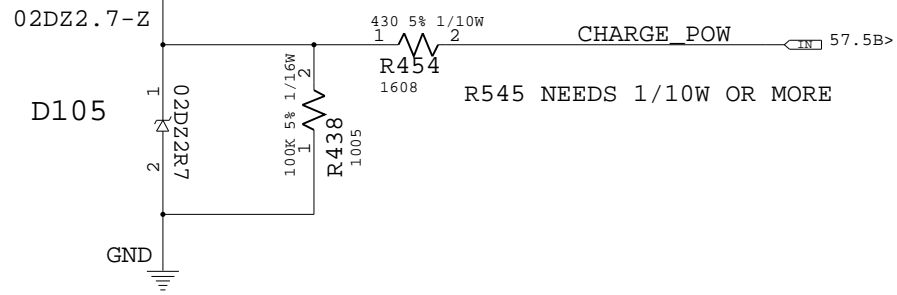

DESIGNER	Y.I	NOV/17/04	PART NO.	39T0120	IBM
CHECKED	Y.Y	NOV/17/04	TITLE	ROME-4 SVT(V0.90)	
APPROVED	T.S	NOV/17/04	CLASS	ATI M24(2/6):LVDS/CRT/TV/TMDS	
THIS DOCUMENT IS THE PROPERTY OF IBM. ITS USE IS AUTHORIZED ONLY FOR RESPONDING TO A REQUEST FOR QUOTATION OR FOR THE PERFORMANCE OF WORK FOR IBM. ALL QUESTIONS MUST BE REFERRED TO THE IBM PURCHASING DEPARTMENT.					IBM CONFIDENTIAL

39T0120

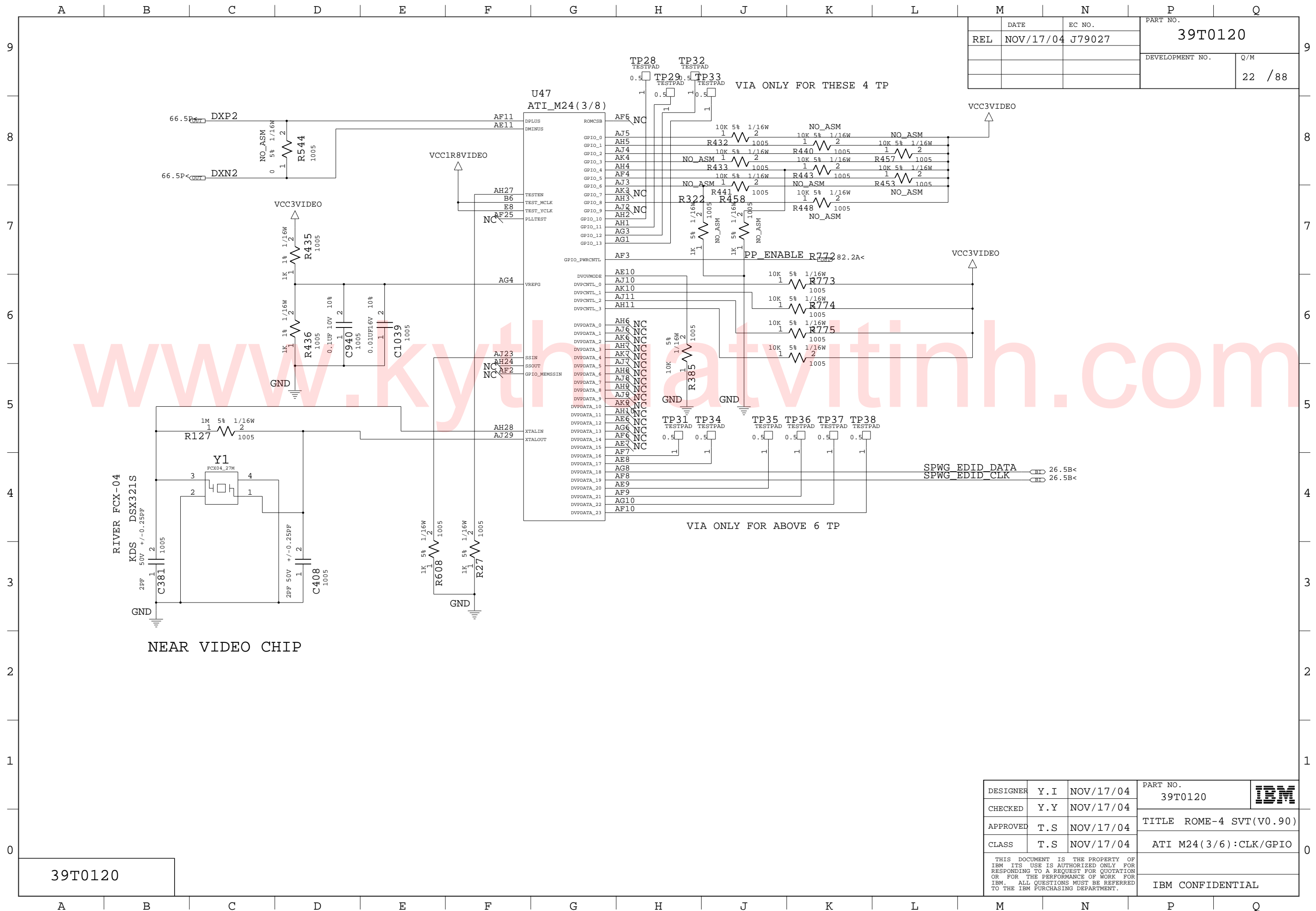

DATE	NOV/17/04	EC NO.	J79027	PART NO.	39T0120
REL				DEVELOPMENT NO.	Q/M
					22 / 88

DESIGNER	Y.I	NOV/17/04	PART NO.	39T0120	IBM
CHECKED	Y.Y	NOV/17/04			
APPROVED	T.S	NOV/17/04	TITLE		ROME-4 SVT(V0.90)
CLASS	T.S	NOV/17/04	ATI M24(3/6):CLK/GPIO		
THIS DOCUMENT IS THE PROPERTY OF IBM ITS USE IS AUTHORIZED ONLY FOR RESPONDING TO A REQUEST FOR QUOTATION OR FOR THE PERFORMANCE OF WORK FOR IBM. ALL QUESTIONS MUST BE REFERRED TO THE IBM PURCHASING DEPARTMENT.					IBM CONFIDENTIAL

39T0120

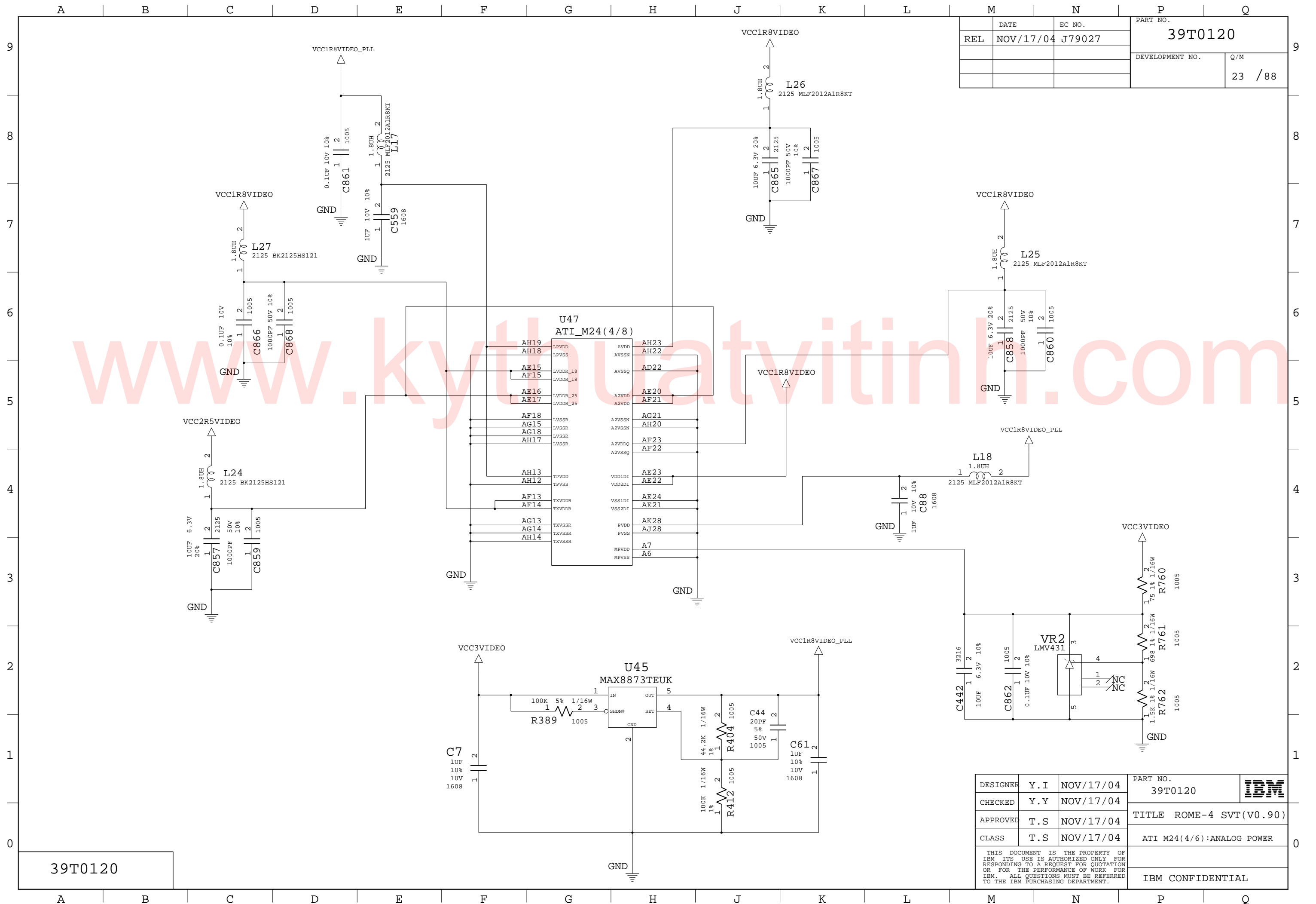

REL	DATE	EC NO.	PART NO.
	NOV/17/04	J79027	39T0120
			DEVELOPMENT NO.
			Q/M
			23 / 88

39T0120

DESIGNER	Y.I	NOV/17/04	PART NO.	39T0120	IBM
CHECKED	Y.Y	NOV/17/04			
APPROVED	T.S	NOV/17/04	TITLE	ROME-4 SVT(V0.90)	
CLASS	T.S	NOV/17/04		ATI M24(4/6):ANALOG POWER	
THIS DOCUMENT IS THE PROPERTY OF IBM ITS USE IS AUTHORIZED ONLY FOR RESPONDING TO A REQUEST FOR QUOTATION OR FOR THE PERFORMANCE OF WORK FOR IBM. ALL QUESTIONS MUST BE REFERRED TO THE IBM PURCHASING DEPARTMENT.				IBM CONFIDENTIAL	

	DATE	EC NO.	PART NO.
REL	NOV/17/04	J79027	39T0120
			DEVELOPMENT NO.
			Q/M
			24 / 88

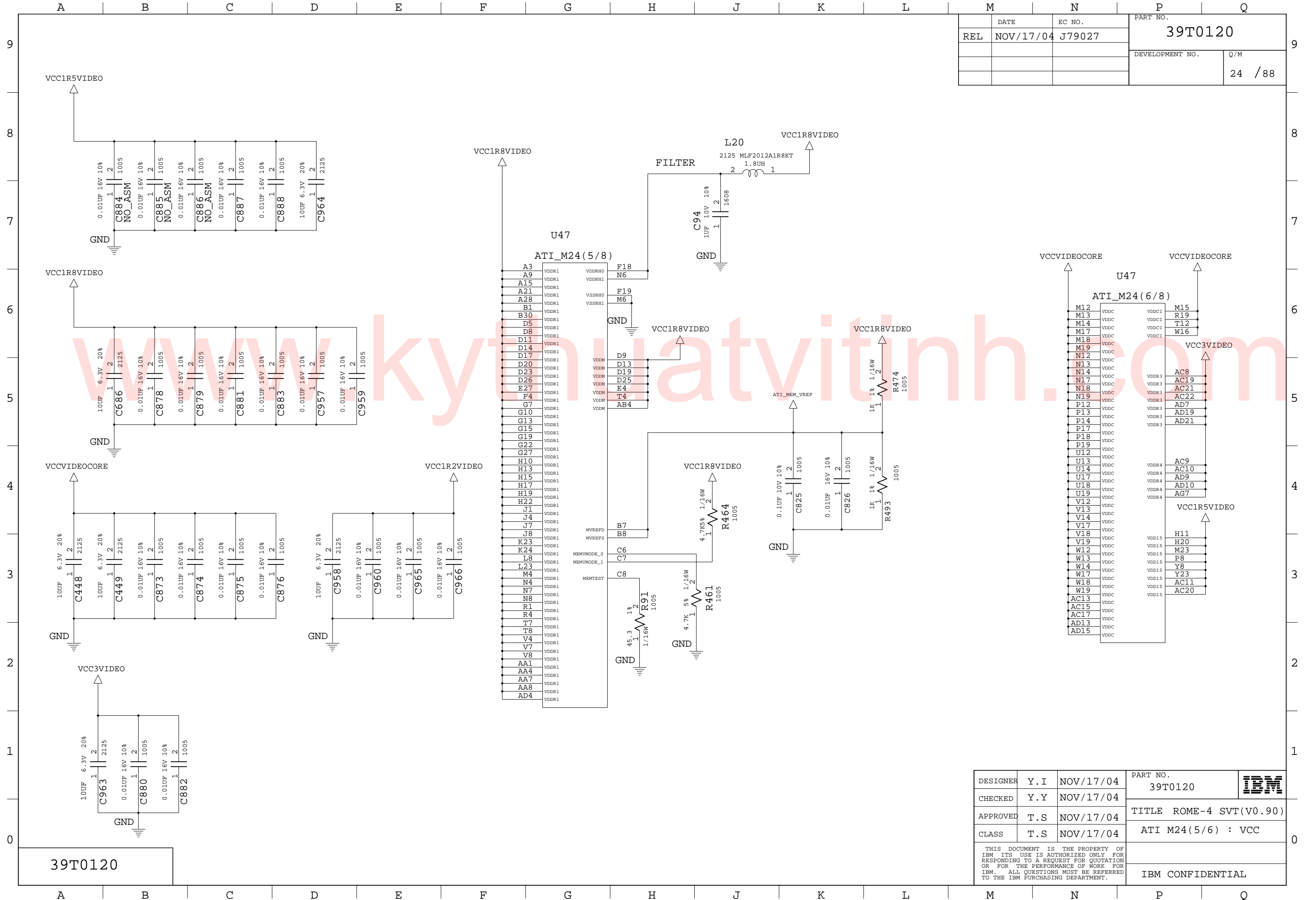

39T0120

DESIGNER	Y.I	NOV/17/04	PART NO.	39T0120	
CHECKED	Y.Y	NOV/17/04			
APPROVED	T.S	NOV/17/04	TITLE	ROME-4 SVT(V0.90)	
CLASS	T.S	NOV/17/04		ATI M24(5/6) : VCC	
THIS DOCUMENT IS THE PROPERTY OF IBM ITS USE IS AUTHORIZED ONLY FOR RESPONDING TO A REQUEST FOR QUOTATION OR FOR THE PERFORMANCE OF WORK FOR IBM. ALL QUESTIONS MUST BE REFERRED TO THE IBM PURCHASING DEPARTMENT.				IBM CONFIDENTIAL	

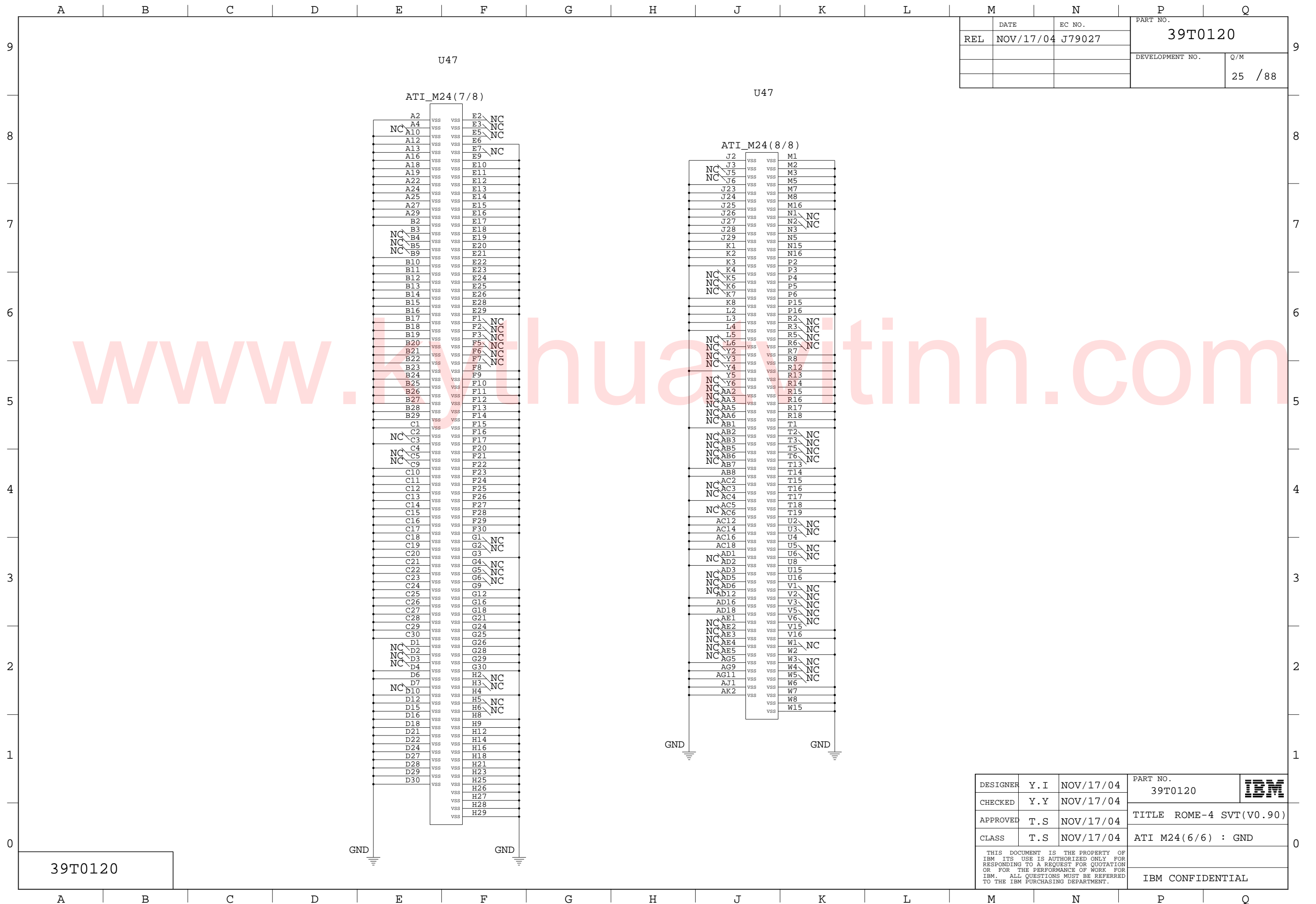

	DATE	EC NO.	PART NO.
REL	NOV/17/04	J79027	39T0120
			DEVELOPMENT NO.
			Q/M
			25 / 88

39T0120

DESIGNER	Y. I	NOV/17/04	PART NO.	39T0120	<b>IBM</b>
CHECKED	Y. Y	NOV/17/04			
APPROVED	T. S	NOV/17/04	TITLE ROME-4 SVT(V0.90)		
CLASS	T. S	NOV/17/04	ATI M24(6/6) : GND		
THIS DOCUMENT IS THE PROPERTY OF IBM. ITS USE IS AUTHORIZED ONLY FOR RESPONDING TO A REQUEST FOR QUOTATION OR FOR THE PERFORMANCE OF WORK FOR IBM. ALL QUESTIONS MUST BE REFERRED TO THE IBM PURCHASING DEPARTMENT.					IBM CONFIDENTIAL

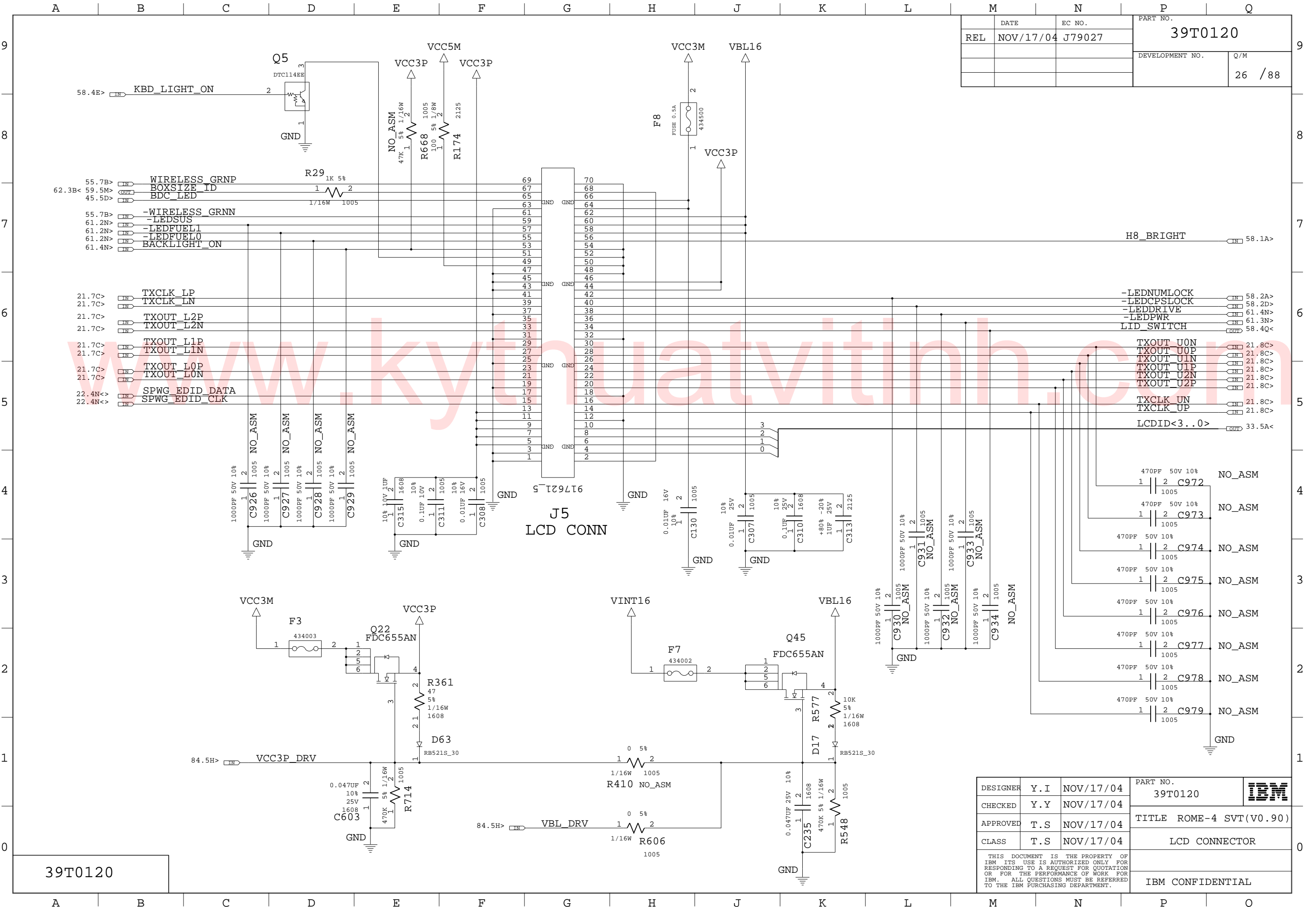

DATE	NOV/17/04	EC NO.	J79027	PART NO.	39T0120
REL				DEVELOPMENT NO.	Q/M
					26 / 88

39T0120

DESIGNER	Y.I	NOV/17/04	PART NO.	39T0120	
CHECKED	Y.Y	NOV/17/04	TITLE	ROME-4 SVT(V0.90)	
APPROVED	T.S	NOV/17/04	CLASS	LCD CONNECTOR	
					IBM CONFIDENTIAL



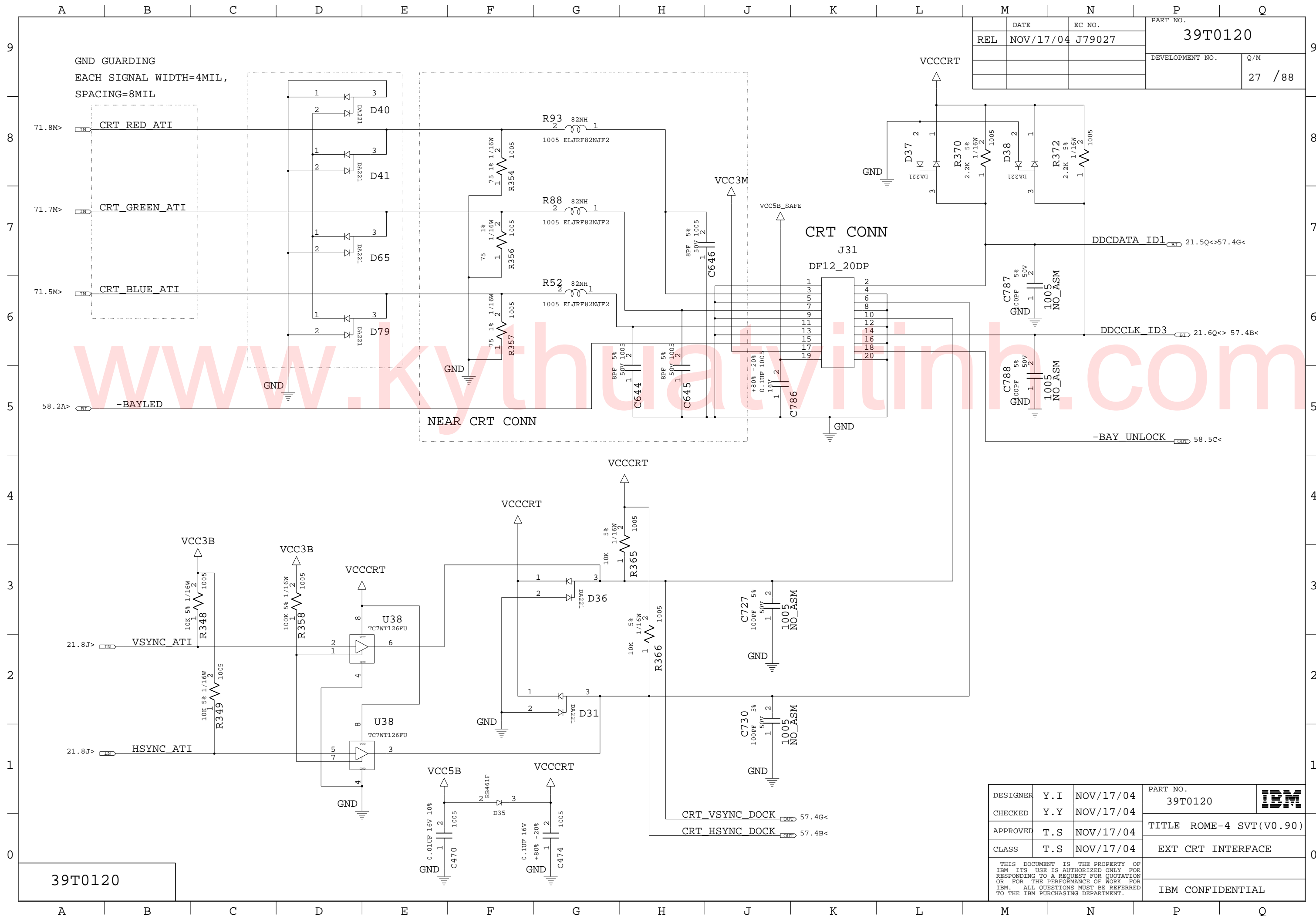

DATE	NOV/17/04	EC NO.	J79027	PART NO.	39T0120
REL				DEVELOPMENT NO.	27 / 88

39T0120

DESIGNER	Y.I	NOV/17/04	PART NO.	39T0120	IBM
CHECKED	Y.Y	NOV/17/04	TITLE	ROME-4 SVT(V0.90)	
APPROVED	T.S	NOV/17/04	CLASS	T.S	EXT CRT INTERFACE
THIS DOCUMENT IS THE PROPERTY OF IBM ITS USE IS AUTHORIZED ONLY FOR RESPONDING TO A REQUEST FOR QUOTATION OR FOR THE PERFORMANCE OF WORK FOR IBM. ALL QUESTIONS MUST BE REFERRED TO THE IBM PURCHASING DEPARTMENT.					IBM CONFIDENTIAL

	DATE	EC NO.	PART NO.	
REL	NOV/17/04	J79027	39T0120	
			DEVELOPMENT NO.	Q/M
				28 / 88

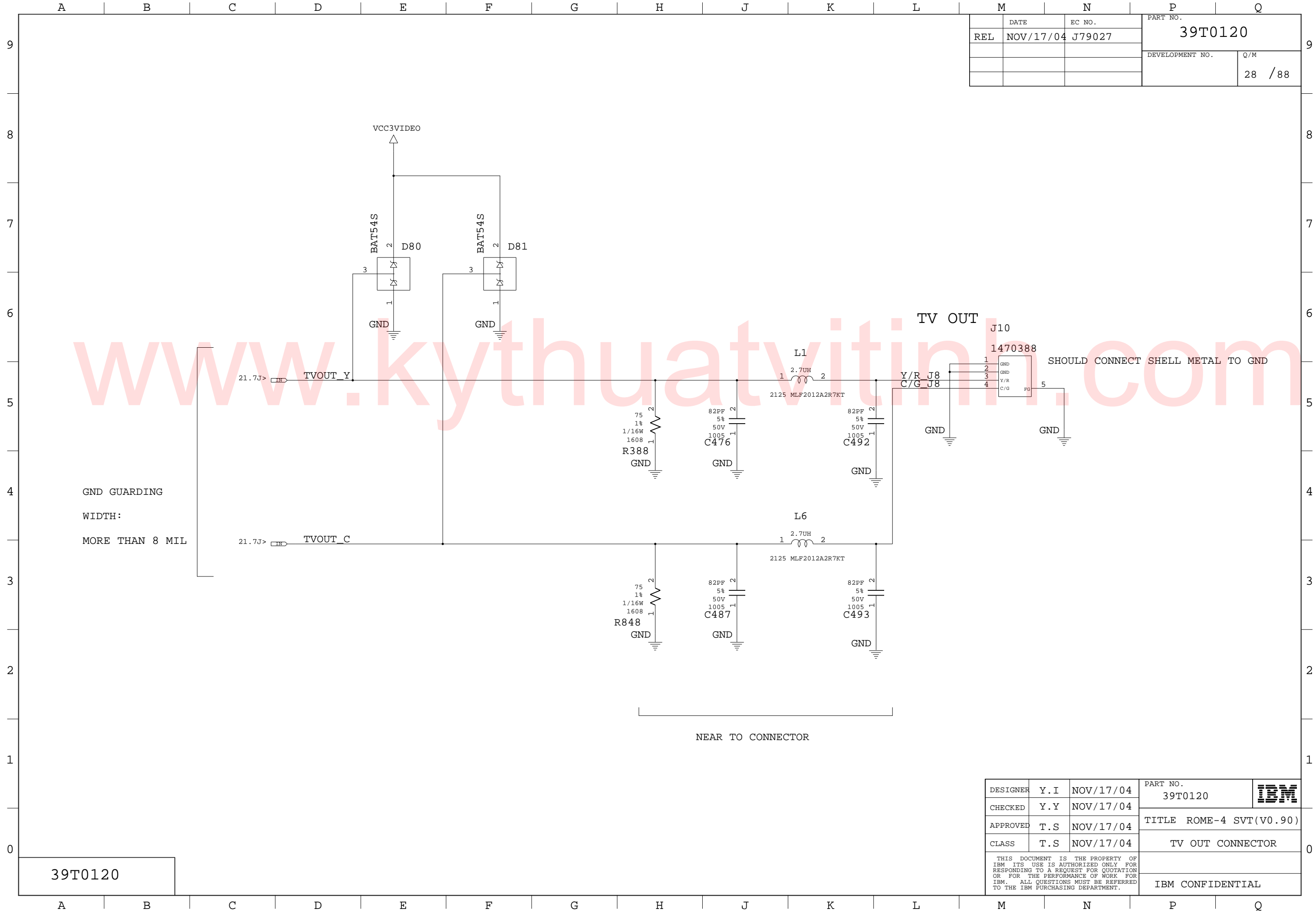

GND GUARDING  
WIDTH:  
MORE THAN 8 MIL

NEAR TO CONNECTOR

39T0120

DESIGNER	Y.I	NOV/17/04	PART NO.	39T0120	<b>IBM</b>
CHECKED	Y.Y	NOV/17/04			
APPROVED	T.S	NOV/17/04	TITLE ROME-4 SVT(V0.90)		
CLASS	T.S	NOV/17/04	TV OUT CONNECTOR		
THIS DOCUMENT IS THE PROPERTY OF IBM ITS USE IS AUTHORIZED ONLY FOR RESPONDING TO A REQUEST FOR QUOTATION OR FOR THE PERFORMANCE OF WORK FOR IBM. ALL QUESTIONS MUST BE REFERRED TO THE IBM PURCHASING DEPARTMENT.				IBM CONFIDENTIAL	

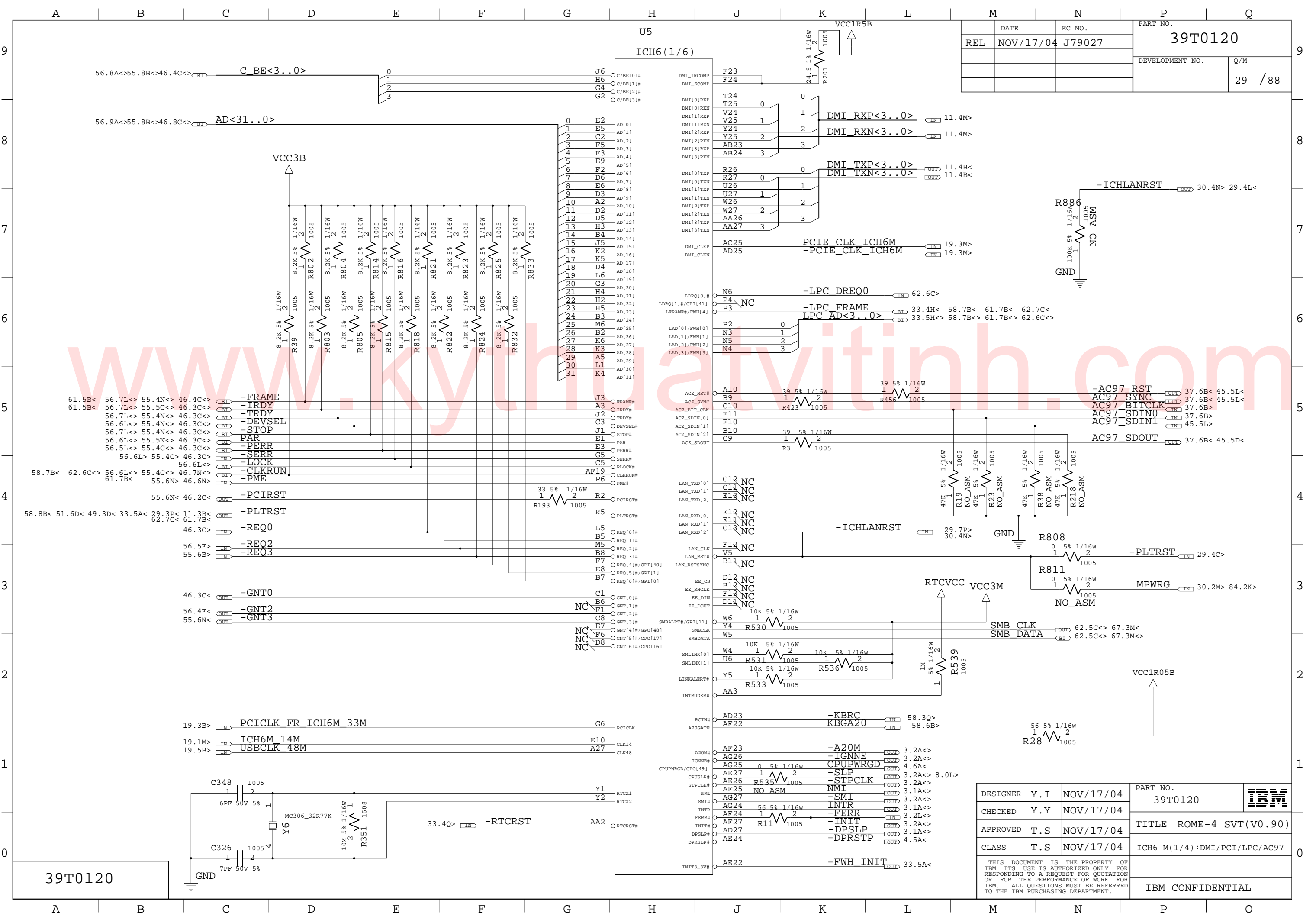

REL	NOV/17/04	J79027	PART NO.	39T0120
			DEVELOPMENT NO.	Q/M
				29 / 88

DESIGNER	Y.I	NOV/17/04	PART NO.	39T0120	IBM
CHECKED	Y.Y	NOV/17/04	TITLE	ROME-4 SVT(V0.90)	
APPROVED	T.S	NOV/17/04	CLASS	ICH6-M(1/4):DMI/PCI/LPC/AC97	
					IBM CONFIDENTIAL

39T0120

THIS DOCUMENT IS THE PROPERTY OF IBM. ITS USE IS AUTHORIZED ONLY FOR RESPONDING TO A REQUEST FOR QUOTATION OR FOR THE PERFORMANCE OF WORK FOR IBM. ALL QUESTIONS MUST BE REFERRED TO THE IBM PURCHASING DEPARTMENT.

REL	DATE	EC NO.	PART NO.
	NOV/17/04	J79027	39T0120
			DEVELOPMENT NO.
			Q/M
			30 / 88

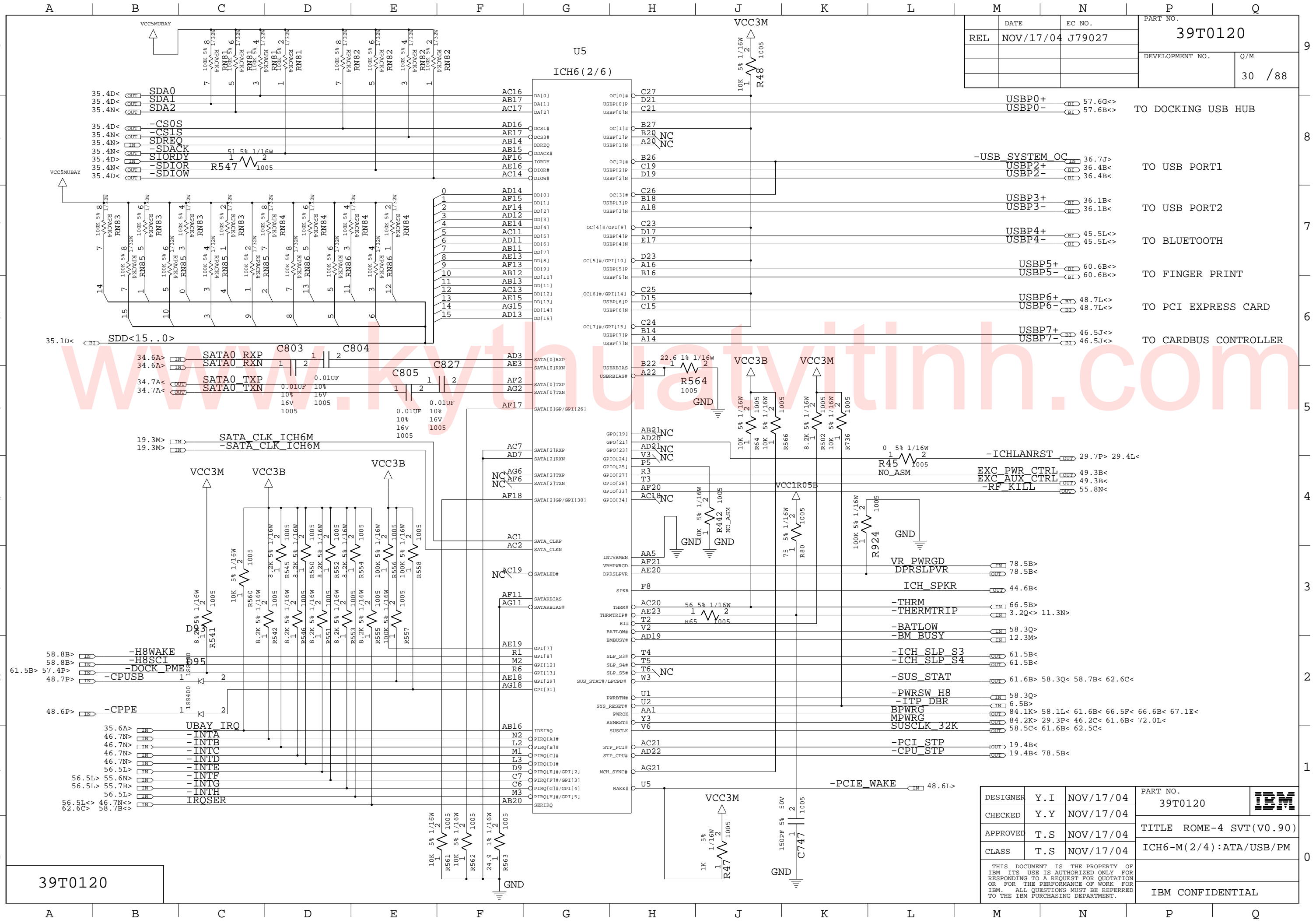

39T0120

DESIGNER	Y.I	NOV/17/04	PART NO.	39T0120	IBM
CHECKED	Y.Y	NOV/17/04	TITLE		
APPROVED	T.S	NOV/17/04	ICH6-M(2/4):ATA/USB/PM		IBM CONFIDENTIAL
CLASS	T.S	NOV/17/04			

THIS DOCUMENT IS THE PROPERTY OF IBM ITS USE IS AUTHORIZED ONLY FOR RESPONDING TO A REQUEST FOR QUOTATION OR FOR THE PERFORMANCE OF WORK FOR IBM. ALL QUESTIONS MUST BE REFERRED TO THE IBM PURCHASING DEPARTMENT.

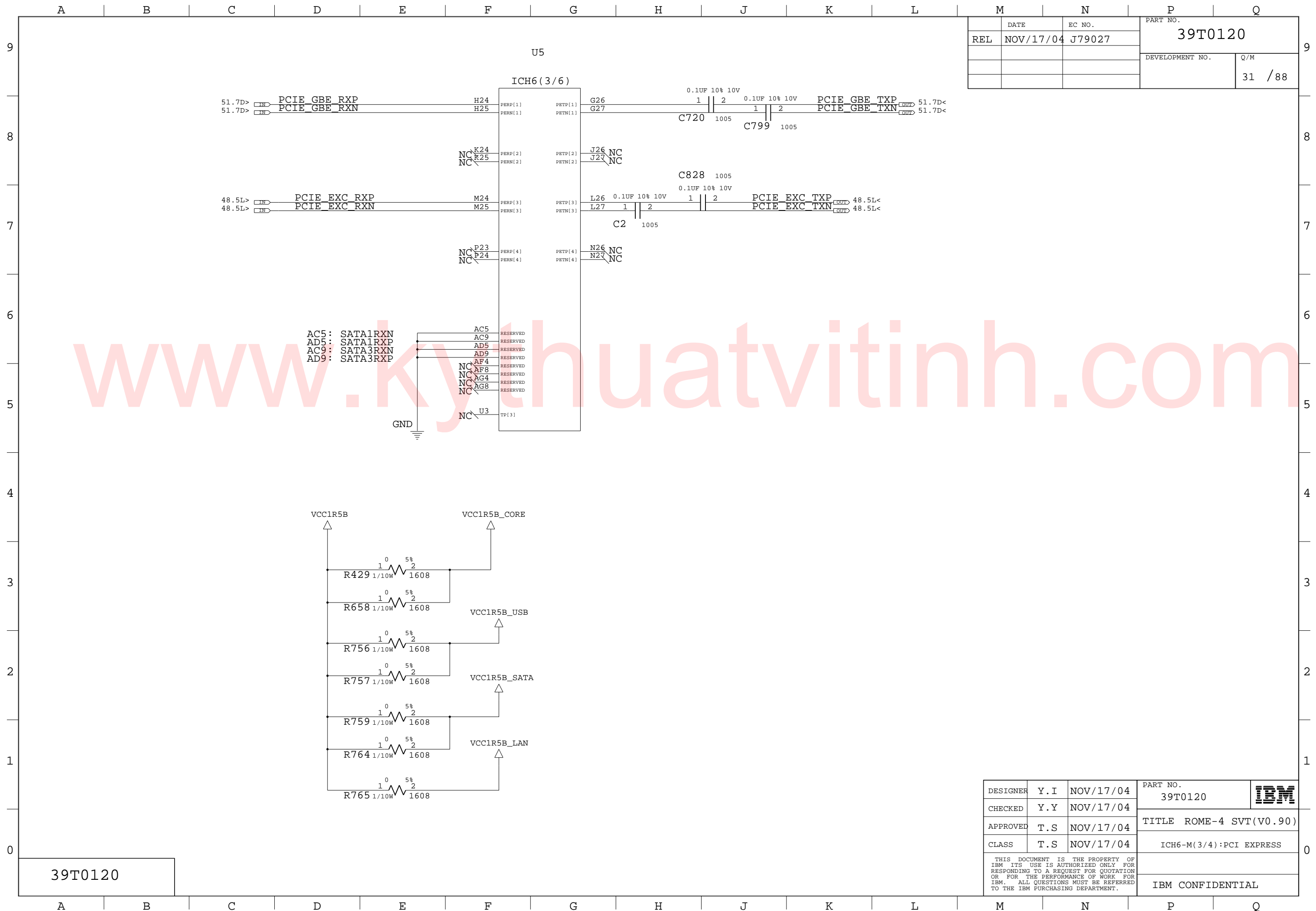

	DATE	EC NO.	PART NO.	
REL	NOV/17/04	J79027	39T0120	
			DEVELOPMENT NO.	Q/M
				31 / 88

www.kyathuatvithinh.com

39T0120

DESIGNER	Y.I	NOV/17/04	PART NO.	39T0120	
CHECKED	Y.Y	NOV/17/04			
APPROVED	T.S	NOV/17/04	TITLE ROME-4 SVT(V0.90)		
CLASS	T.S	NOV/17/04	ICH6-M(3/4):PCI EXPRESS		
THIS DOCUMENT IS THE PROPERTY OF IBM. ITS USE IS AUTHORIZED ONLY FOR RESPONDING TO A REQUEST FOR QUOTATION OR FOR THE PERFORMANCE OF WORK FOR IBM. ALL QUESTIONS MUST BE REFERRED TO THE IBM PURCHASING DEPARTMENT.				IBM CONFIDENTIAL	



REL	DATE	EC NO.	PART NO.
	NOV/17/04	J79027	39T0120
			DEVELOPMENT NO.
			Q/M
			32 / 88

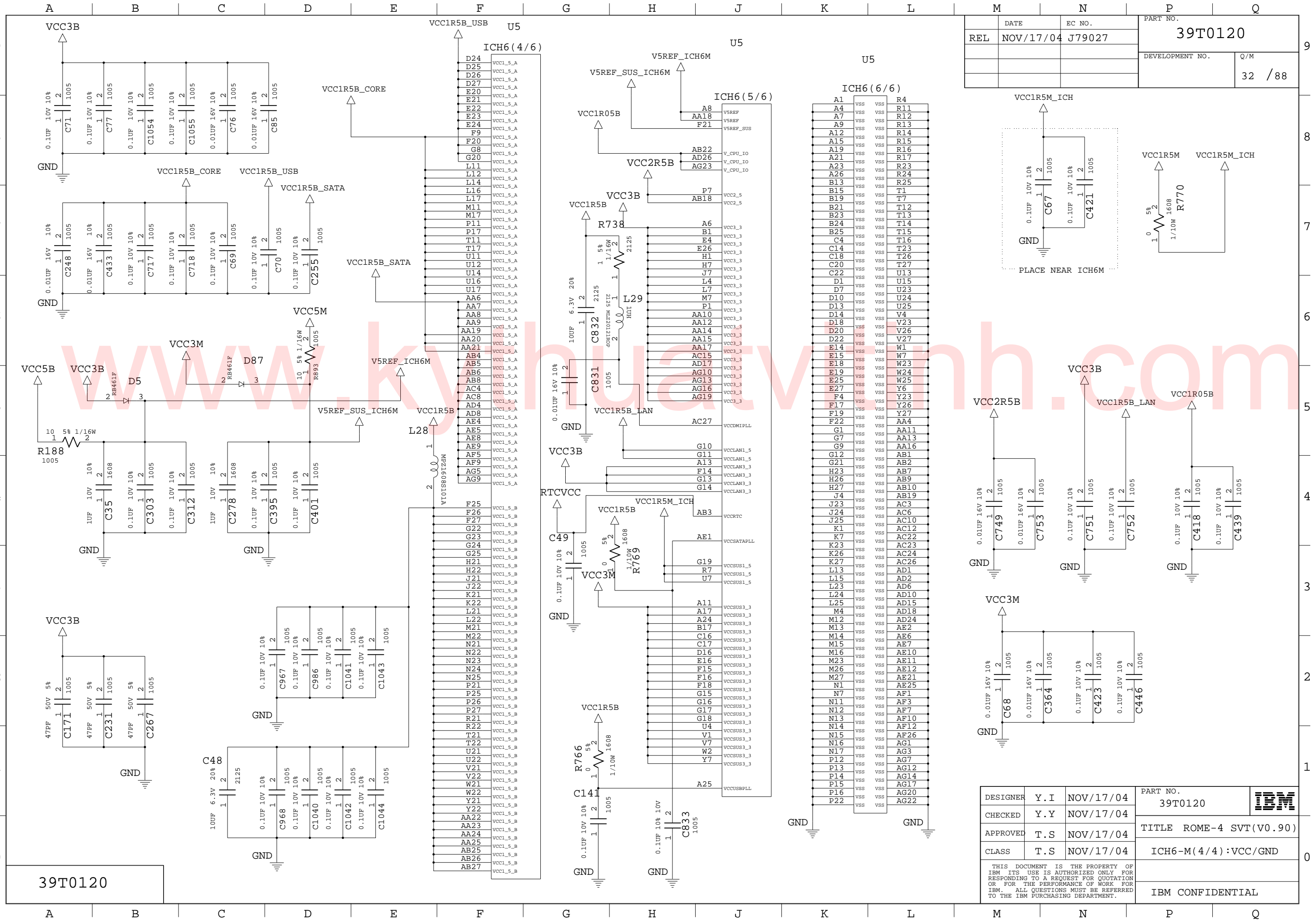

39T0120

DESIGNER	Y.I	NOV/17/04	PART NO.	39T0120	IBM
CHECKED	Y.Y	NOV/17/04			
APPROVED	T.S	NOV/17/04	TITLE	ROME-4 SVT(V0.90)	
CLASS	T.S	NOV/17/04		ICH6-M(4/4):VCC/GND	
THIS DOCUMENT IS THE PROPERTY OF IBM ITS USE IS AUTHORIZED ONLY FOR RESPONDING TO A REQUEST FOR QUOTATION OR FOR THE PERFORMANCE OF WORK FOR IBM. ALL QUESTIONS MUST BE REFERRED TO THE IBM PURCHASING DEPARTMENT.				IBM CONFIDENTIAL	



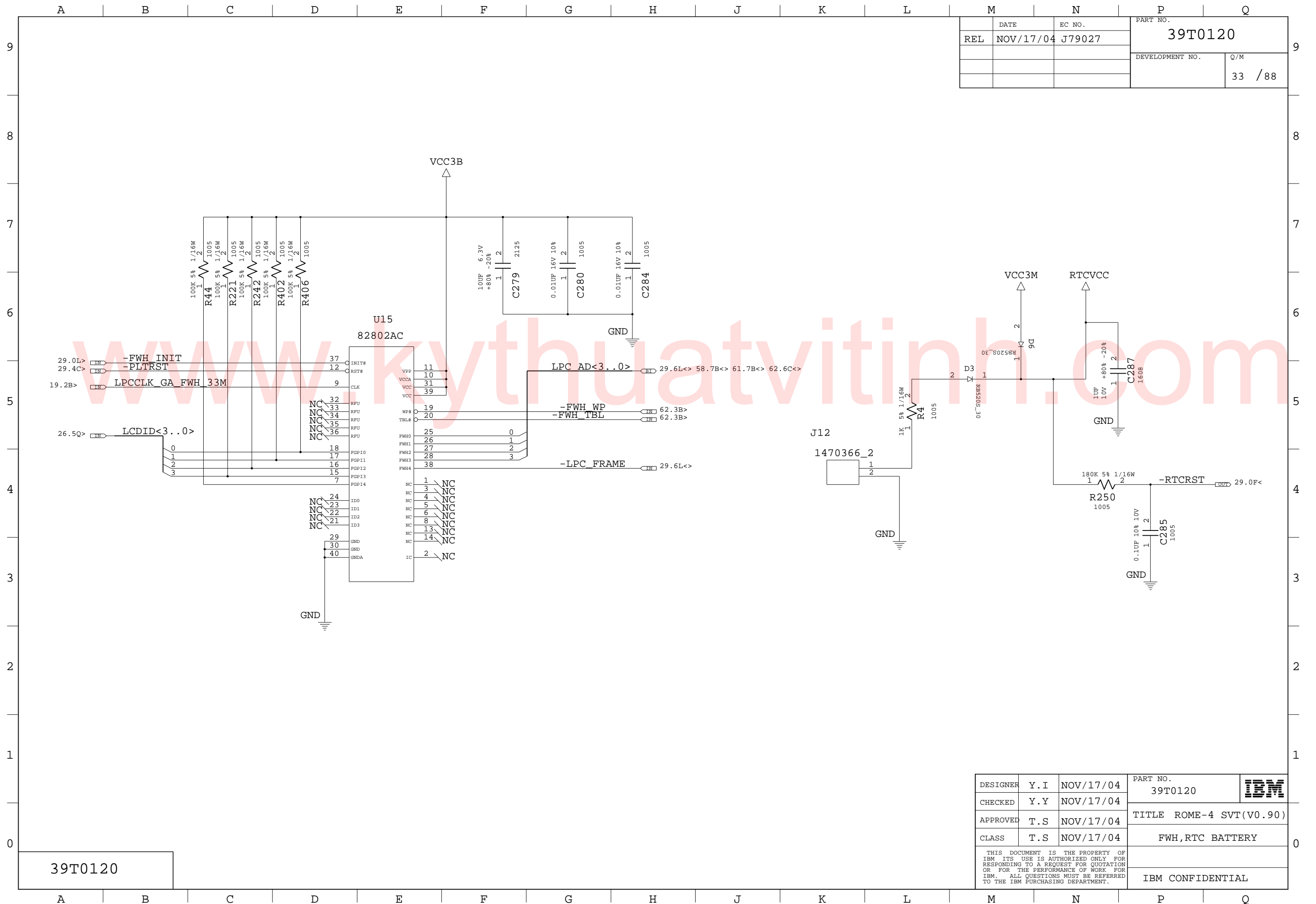

DATE	NOV/17/04	EC NO.	J79027	PART NO.	39T0120
REL				DEVELOPMENT NO.	Q/M
					33 / 88

39T0120

DESIGNER	Y.I	NOV/17/04	PART NO.	39T0120	<b>IBM</b>
CHECKED	Y.Y	NOV/17/04	TITLE ROME-4 SVT(V0.90)		
APPROVED	T.S	NOV/17/04	FWH, RTC BATTERY		
CLASS	T.S	NOV/17/04	THIS DOCUMENT IS THE PROPERTY OF IBM ITS USE IS AUTHORIZED ONLY FOR RESPONDING TO A REQUEST FOR QUOTATION OR FOR THE PERFORMANCE OF WORK FOR IBM. ALL QUESTIONS MUST BE REFERRED TO THE IBM PURCHASING DEPARTMENT.		IBM CONFIDENTIAL

REL	DATE	EC NO.	PART NO.
	NOV/17/04	J79027	39T0120
			DEVELOPMENT NO.
			Q/M
			34 / 88

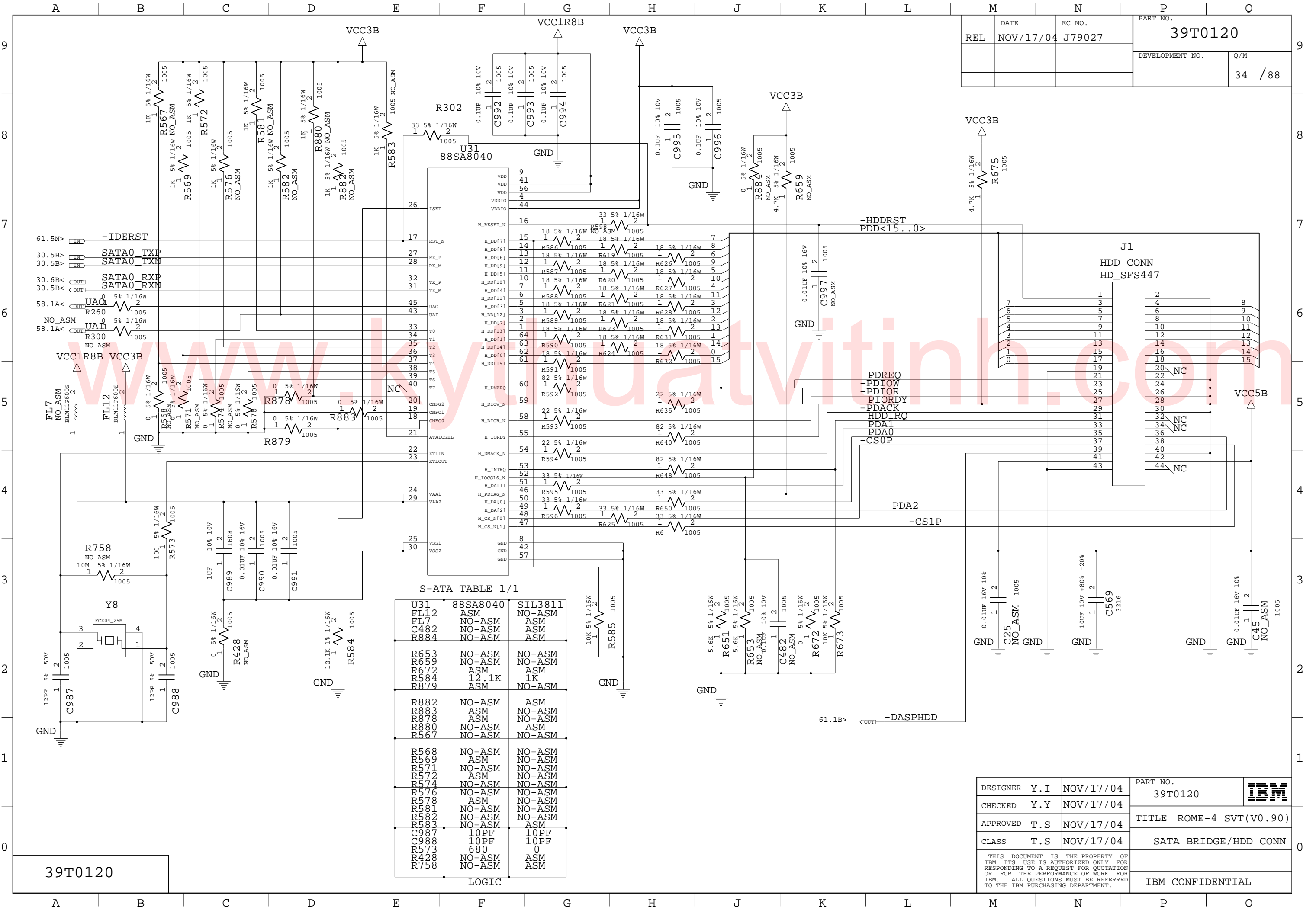

S-ATA TABLE 1/1

U31	88SA8040	SIL3811
FL12	ASM	NO-ASM
FL7	NO-ASM	ASM
C482	NO-ASM	ASM
R884	NO-ASM	ASM
R6	NO-ASM	NO-ASM
R653	NO-ASM	NO-ASM
R654	NO-ASM	NO-ASM
R655	NO-ASM	NO-ASM
R656	NO-ASM	NO-ASM
R657	NO-ASM	NO-ASM
R658	NO-ASM	NO-ASM
R659	NO-ASM	NO-ASM
R660	NO-ASM	NO-ASM
R661	NO-ASM	NO-ASM
R662	NO-ASM	NO-ASM
R663	NO-ASM	NO-ASM
R664	NO-ASM	NO-ASM
R665	NO-ASM	NO-ASM
R666	NO-ASM	NO-ASM
R667	NO-ASM	NO-ASM
R668	NO-ASM	NO-ASM
R669	NO-ASM	NO-ASM
R670	NO-ASM	NO-ASM
R671	NO-ASM	NO-ASM
R672	NO-ASM	NO-ASM
R673	NO-ASM	NO-ASM
R674	NO-ASM	NO-ASM
R675	NO-ASM	NO-ASM
R676	NO-ASM	NO-ASM
R677	NO-ASM	NO-ASM
R678	NO-ASM	NO-ASM
R679	NO-ASM	NO-ASM
R680	NO-ASM	NO-ASM
R681	NO-ASM	NO-ASM
R682	NO-ASM	NO-ASM
R683	NO-ASM	NO-ASM
R684	NO-ASM	NO-ASM
R685	NO-ASM	NO-ASM
R686	NO-ASM	NO-ASM
R687	NO-ASM	NO-ASM
R688	NO-ASM	NO-ASM
R689	NO-ASM	NO-ASM
R690	NO-ASM	NO-ASM
R691	NO-ASM	NO-ASM
R692	NO-ASM	NO-ASM
R693	NO-ASM	NO-ASM
R694	NO-ASM	NO-ASM
R695	NO-ASM	NO-ASM
R696	NO-ASM	NO-ASM
R697	NO-ASM	NO-ASM
R698	NO-ASM	NO-ASM
R699	NO-ASM	NO-ASM
R700	NO-ASM	NO-ASM
R701	NO-ASM	NO-ASM
R702	NO-ASM	NO-ASM
R703	NO-ASM	NO-ASM
R704	NO-ASM	NO-ASM
R705	NO-ASM	NO-ASM
R706	NO-ASM	NO-ASM
R707	NO-ASM	NO-ASM
R708	NO-ASM	NO-ASM
R709	NO-ASM	NO-ASM
R710	NO-ASM	NO-ASM
R711	NO-ASM	NO-ASM
R712	NO-ASM	NO-ASM
R713	NO-ASM	NO-ASM
R714	NO-ASM	NO-ASM
R715	NO-ASM	NO-ASM
R716	NO-ASM	NO-ASM
R717	NO-ASM	NO-ASM
R718	NO-ASM	NO-ASM
R719	NO-ASM	NO-ASM
R720	NO-ASM	NO-ASM
R721	NO-ASM	NO-ASM
R722	NO-ASM	NO-ASM
R723	NO-ASM	NO-ASM
R724	NO-ASM	NO-ASM
R725	NO-ASM	NO-ASM
R726	NO-ASM	NO-ASM
R727	NO-ASM	NO-ASM
R728	NO-ASM	NO-ASM
R729	NO-ASM	NO-ASM
R730	NO-ASM	NO-ASM
R731	NO-ASM	NO-ASM
R732	NO-ASM	NO-ASM
R733	NO-ASM	NO-ASM
R734	NO-ASM	NO-ASM
R735	NO-ASM	NO-ASM
R736	NO-ASM	NO-ASM
R737	NO-ASM	NO-ASM
R738	NO-ASM	NO-ASM
R739	NO-ASM	NO-ASM
R740	NO-ASM	NO-ASM
R741	NO-ASM	NO-ASM
R742	NO-ASM	NO-ASM
R743	NO-ASM	NO-ASM
R744	NO-ASM	NO-ASM
R745	NO-ASM	NO-ASM
R746	NO-ASM	NO-ASM
R747	NO-ASM	NO-ASM
R748	NO-ASM	NO-ASM
R749	NO-ASM	NO-ASM
R750	NO-ASM	NO-ASM
R751	NO-ASM	NO-ASM
R752	NO-ASM	NO-ASM
R753	NO-ASM	NO-ASM
R754	NO-ASM	NO-ASM
R755	NO-ASM	NO-ASM
R756	NO-ASM	NO-ASM
R757	NO-ASM	NO-ASM
R758	NO-ASM	NO-ASM

DESIGNER	Y.I	NOV/17/04	PART NO.	39T0120	IBM
CHECKED	Y.Y	NOV/17/04			
APPROVED	T.S	NOV/17/04	TITLE	ROME-4 SVT(V0.90)	
CLASS	T.S	NOV/17/04		SATA BRIDGE/HDD CONN	
THIS DOCUMENT IS THE PROPERTY OF IBM. ITS USE IS AUTHORIZED ONLY FOR RESPONDING TO A REQUEST FOR QUOTATION OR FOR THE PERFORMANCE OF WORK FOR IBM. ALL QUESTIONS MUST BE REFERRED TO THE IBM PURCHASING DEPARTMENT.					IBM CONFIDENTIAL

39T0120

LOGIC

REL	DATE	EC NO.	PART NO.
	NOV/17/04	J79027	39T0120
			DEVELOPMENT NO.
			Q/M
			35 / 88

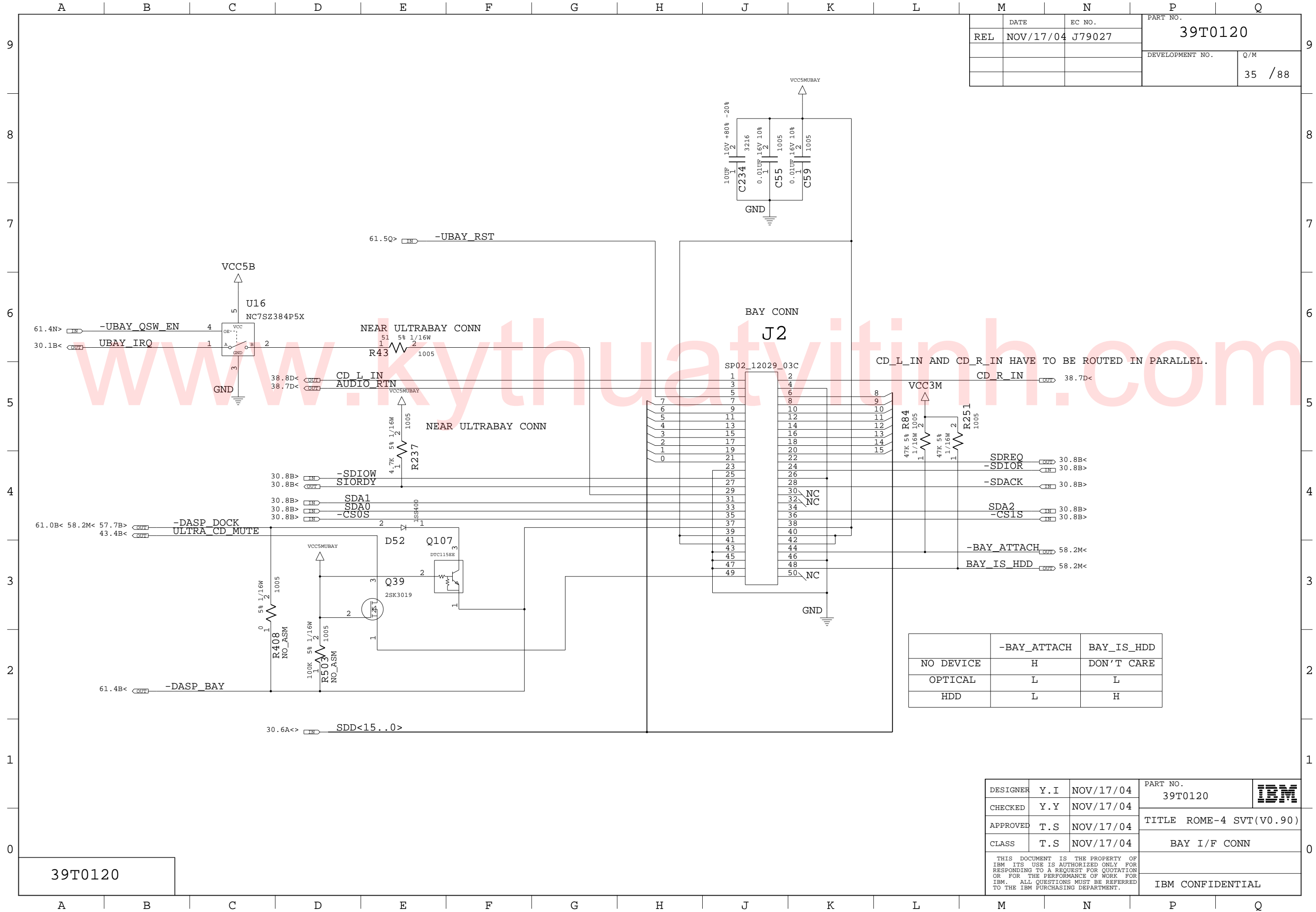

CD\_L\_IN AND CD\_R\_IN HAVE TO BE ROUTED IN PARALLEL.

	-BAY_ATTACH	BAY_IS_HDD
NO DEVICE	H	DON'T CARE
OPTICAL	L	L
HDD	L	H

DESIGNER	Y.I	NOV/17/04	PART NO.	39T0120	
CHECKED	Y.Y	NOV/17/04			
APPROVED	T.S	NOV/17/04	TITLE ROME-4 SVT(V0.90)		
CLASS	T.S	NOV/17/04	BAY I/F CONN		
THIS DOCUMENT IS THE PROPERTY OF IBM ITS USE IS AUTHORIZED ONLY FOR RESPONDING TO A REQUEST FOR QUOTATION OR FOR THE PERFORMANCE OF WORK FOR IBM. ALL QUESTIONS MUST BE REFERRED TO THE IBM PURCHASING DEPARTMENT.					IBM CONFIDENTIAL

39T0120

	DATE	EC NO.	PART NO.
REL	NOV/17/04	J79027	39T0120
			DEVELOPMENT NO.
			Q/M
			36 / 88

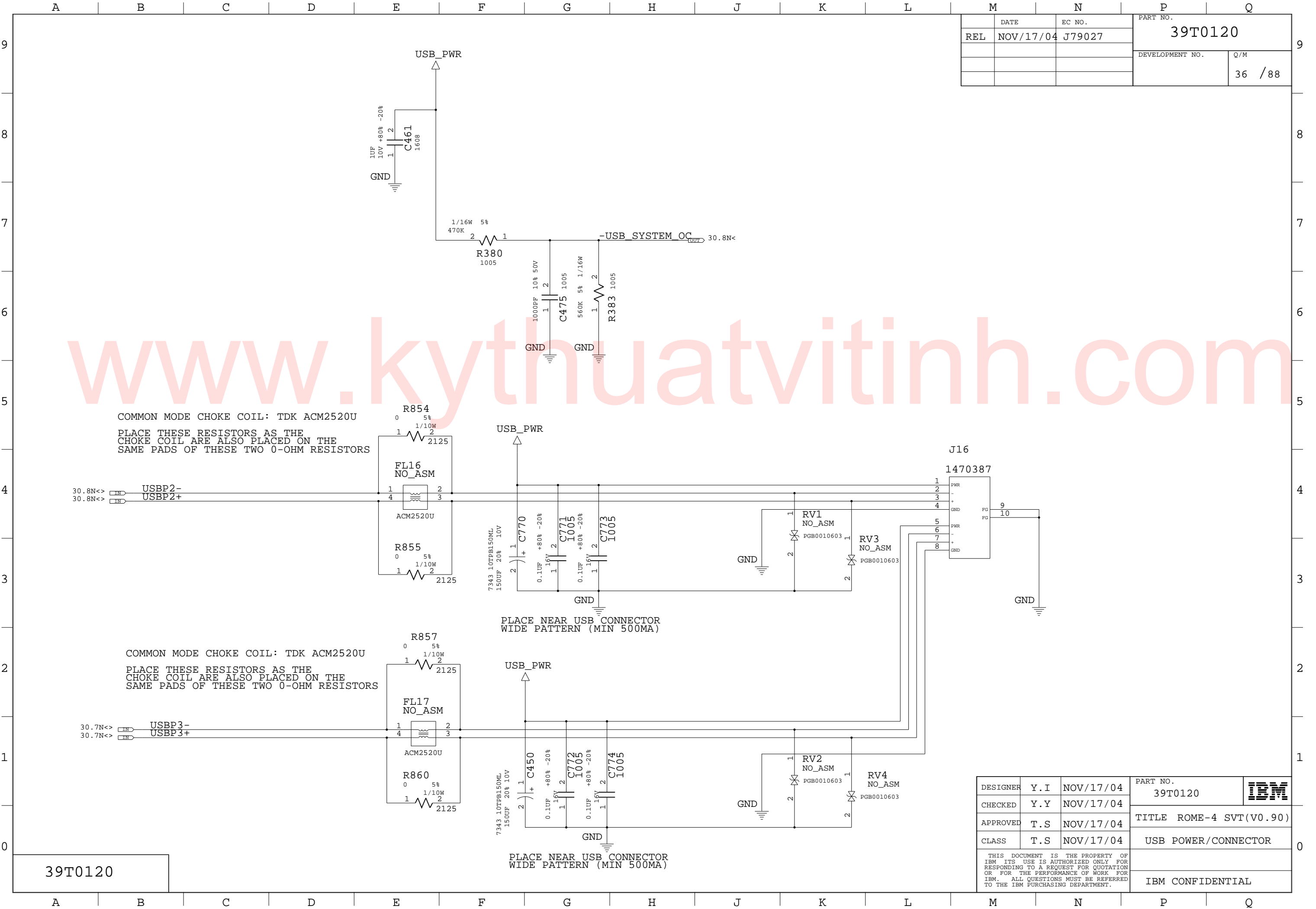

39T0120

DESIGNER	Y.I	NOV/17/04	PART NO.	39T0120	IBM
CHECKED	Y.Y	NOV/17/04			
APPROVED	T.S	NOV/17/04	TITLE ROME-4 SVT(V0.90)		
CLASS	T.S	NOV/17/04	USB POWER/CONNECTOR		
THIS DOCUMENT IS THE PROPERTY OF IBM ITS USE IS AUTHORIZED ONLY FOR RESPONDING TO A REQUEST FOR QUOTATION OR FOR THE PERFORMANCE OF WORK FOR IBM. ALL QUESTIONS MUST BE REFERRED TO THE IBM PURCHASING DEPARTMENT.				IBM CONFIDENTIAL	

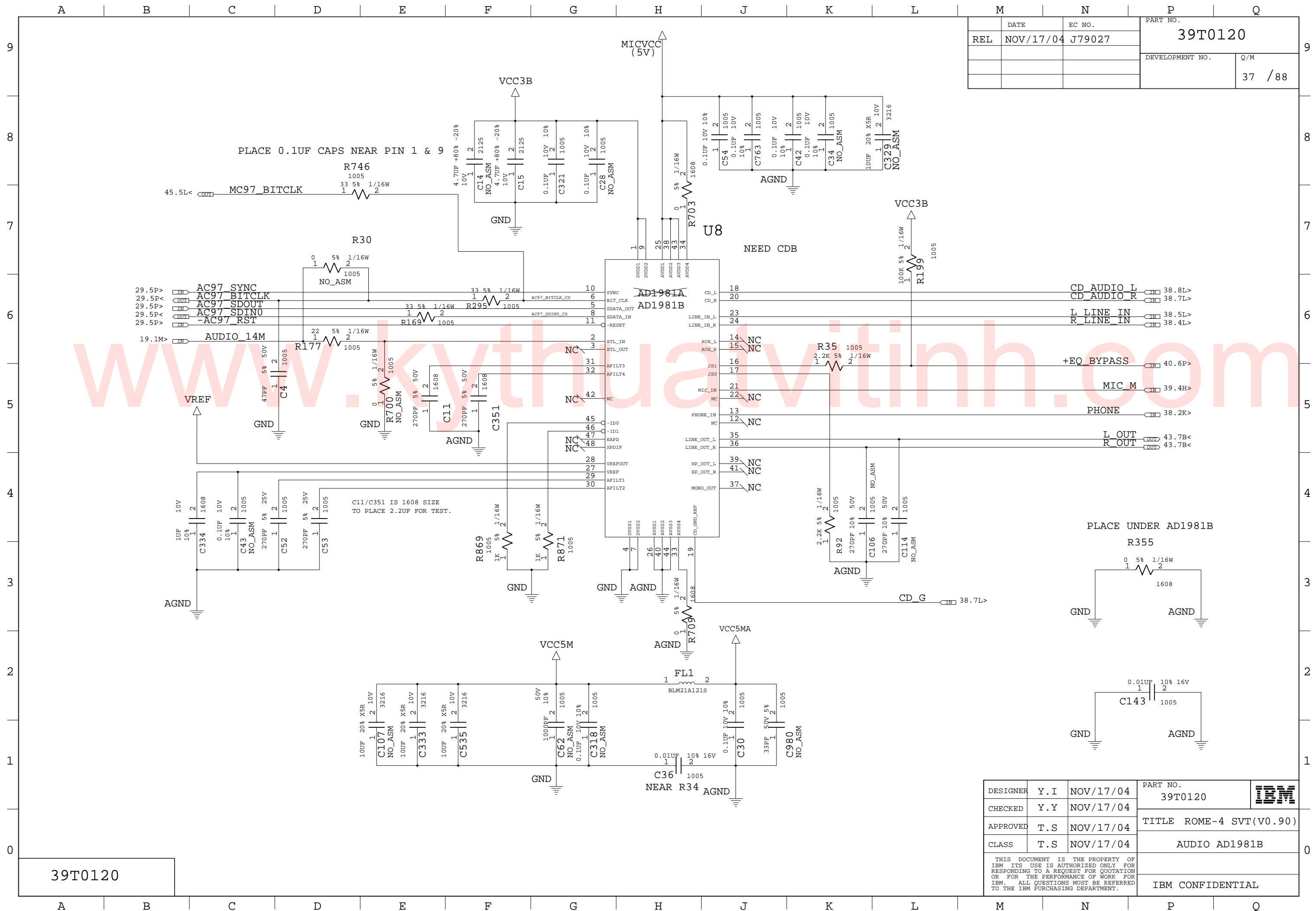

DATE	NOV/17/04	EC NO.	J79027	PART NO.	39T0120
REL				DEVELOPMENT NO.	37 / 88

39T0120

DESIGNER	Y.I	NOV/17/04	PART NO.	39T0120	IBM
CHECKED	Y.Y	NOV/17/04	TITLE	ROME-4 SVT(V0.90)	
APPROVED	T.S	NOV/17/04	CLASS	AUDIO AD1981B	
THIS DOCUMENT IS THE PROPERTY OF IBM ITS USE IS AUTHORIZED ONLY FOR RESPONDING TO A REQUEST FOR QUOTATION OR FOR THE PERFORMANCE OF WORK FOR IBM. ALL QUESTIONS MUST BE REFERRED TO THE IBM PURCHASING DEPARTMENT.					IBM CONFIDENTIAL

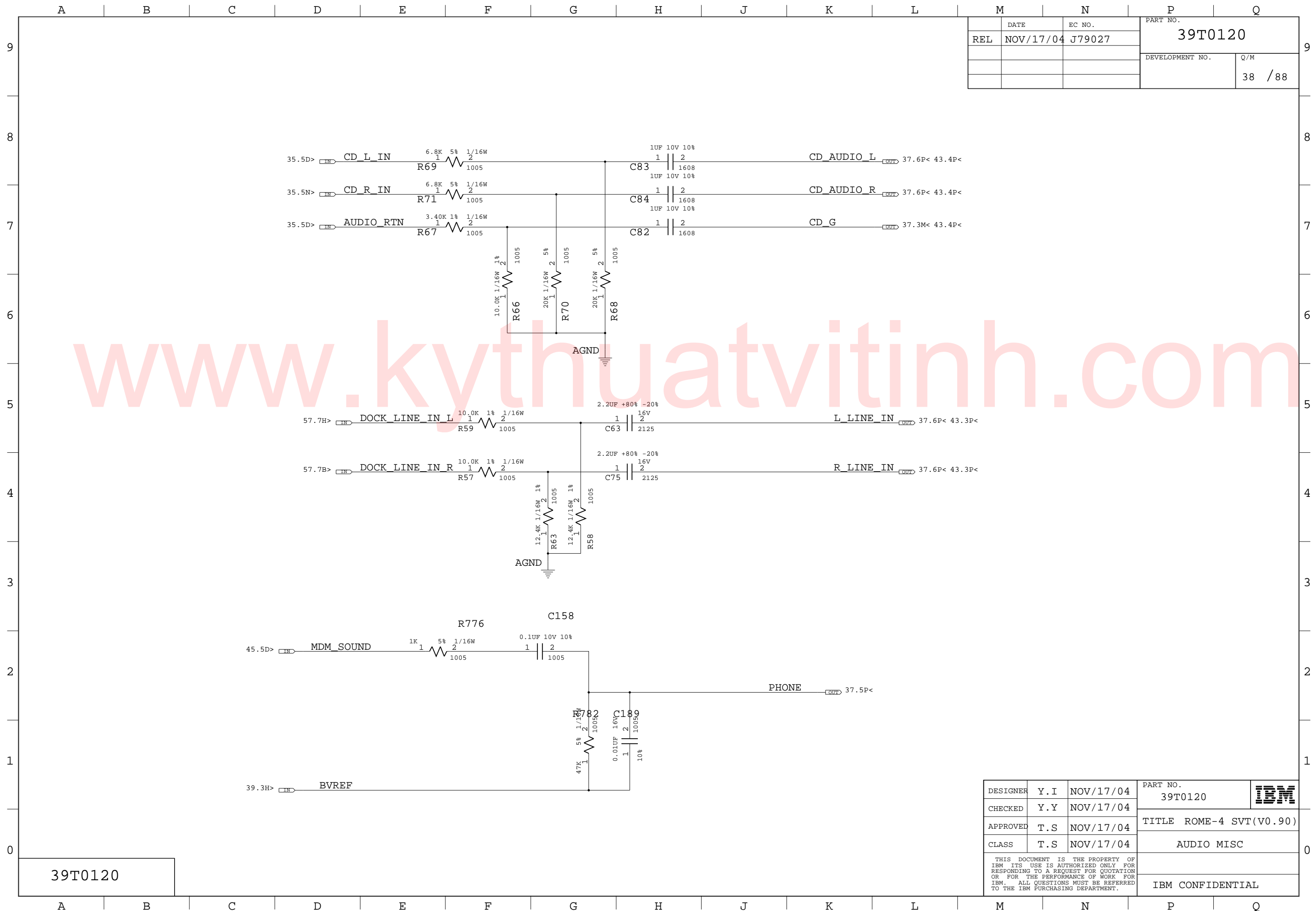

REL	DATE	EC NO.	PART NO.	
	NOV/17/04	J79027	39T0120	
			DEVELOPMENT NO.	Q/M
				38 / 88

39T0120

DESIGNER	Y.I	NOV/17/04	PART NO.	IBM
CHECKED	Y.Y	NOV/17/04	39T0120	
APPROVED	T.S	NOV/17/04	TITLE ROME-4 SVT(V0.90)	
CLASS	T.S	NOV/17/04	AUDIO MISC	
THIS DOCUMENT IS THE PROPERTY OF IBM ITS USE IS AUTHORIZED ONLY FOR RESPONDING TO A REQUEST FOR QUOTATION OR FOR THE PERFORMANCE OF WORK FOR IBM. ALL QUESTIONS MUST BE REFERRED TO THE IBM PURCHASING DEPARTMENT.				IBM CONFIDENTIAL



DATE	NOV/17/04	EC NO.	J79027	PART NO.	39T0120
REL				DEVELOPMENT NO.	39 / 88
				Q/M	

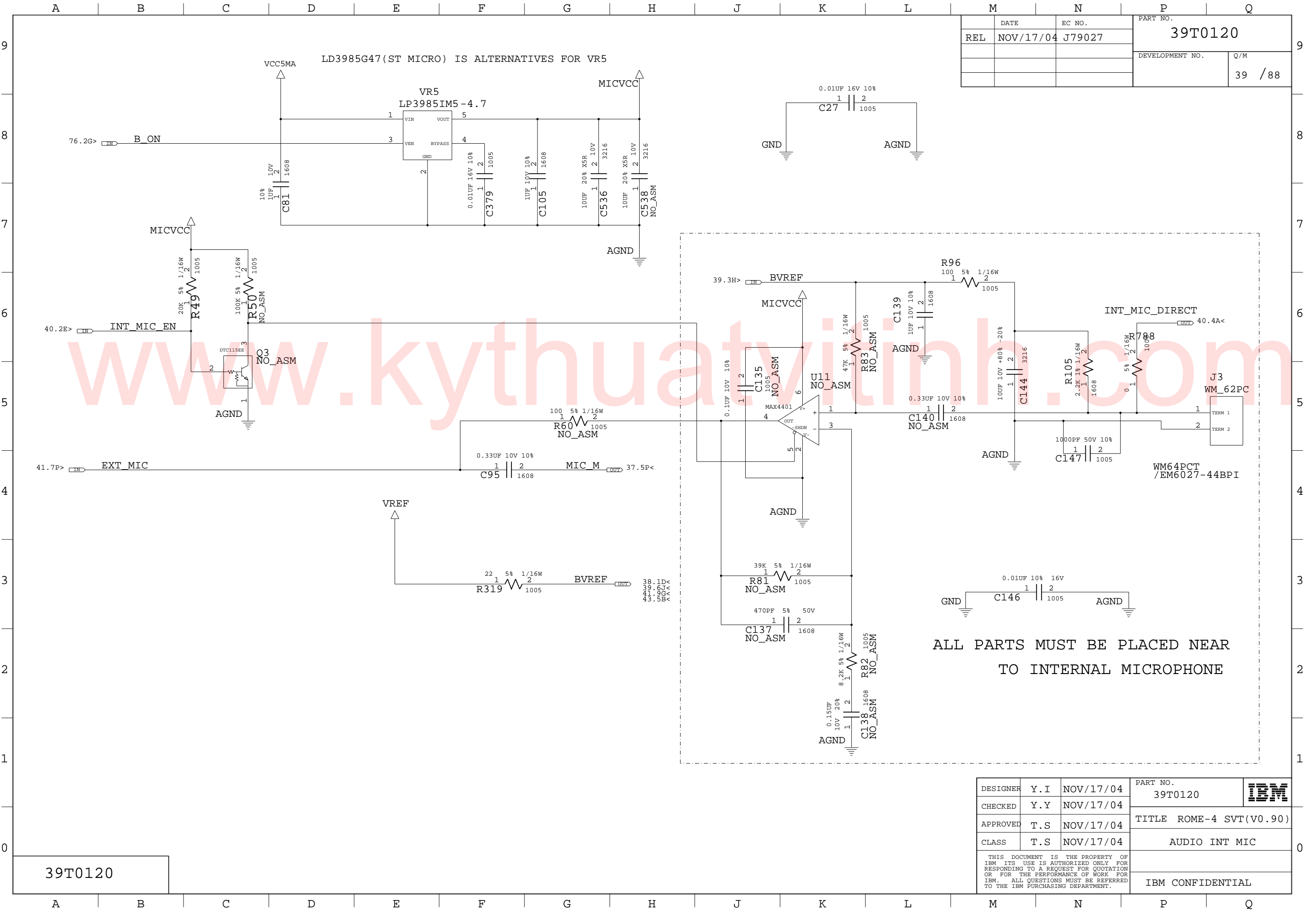

39T0120

DESIGNER	Y.I	NOV/17/04	PART NO.	39T0120	
CHECKED	Y.Y	NOV/17/04	TITLE	ROME-4 SVT(V0.90)	
APPROVED	T.S	NOV/17/04	CLASS	AUDIO INT MIC	
THIS DOCUMENT IS THE PROPERTY OF IBM ITS USE IS AUTHORIZED ONLY FOR RESPONDING TO A REQUEST FOR QUOTATION OR FOR THE PERFORMANCE OF WORK FOR IBM. ALL QUESTIONS MUST BE REFERRED TO THE IBM PURCHASING DEPARTMENT.				IBM CONFIDENTIAL	

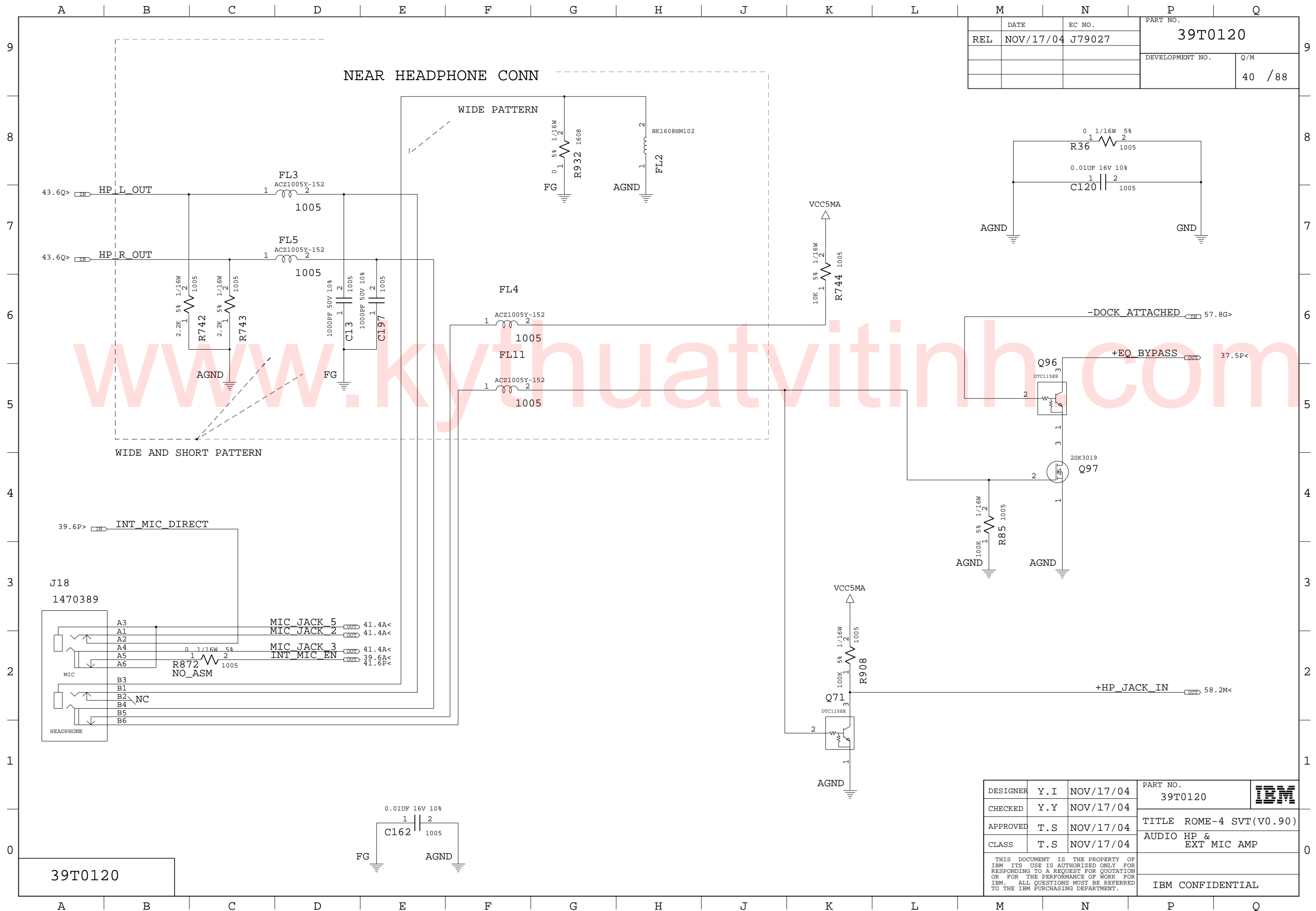

DATE	NOV/17/04	EC NO.	J79027	PART NO.	39T0120
REL				DEVELOPMENT NO.	40 / 88
				Q/M	

39T0120

DESIGNER	Y.I	NOV/17/04	PART NO.	39T0120	<b>IBM</b>
CHECKED	Y.Y	NOV/17/04	TITLE	ROME-4 SVT(V0.90)	
APPROVED	T.S	NOV/17/04	CLASS	AUDIO HP & EXT MIC AMP	
THIS DOCUMENT IS THE PROPERTY OF IBM ITS USE IS AUTHORIZED ONLY FOR RESPONDING TO A REQUEST FOR QUOTATION OR FOR THE PERFORMANCE OF WORK FOR IBM. ALL QUESTIONS MUST BE REFERRED TO THE IBM PURCHASING DEPARTMENT.					IBM CONFIDENTIAL

DATE	EC NO.	PART NO.	
REL NOV/17/04	J79027	39T0120	
		DEVELOPMENT NO.	Q/M
			41 / 88

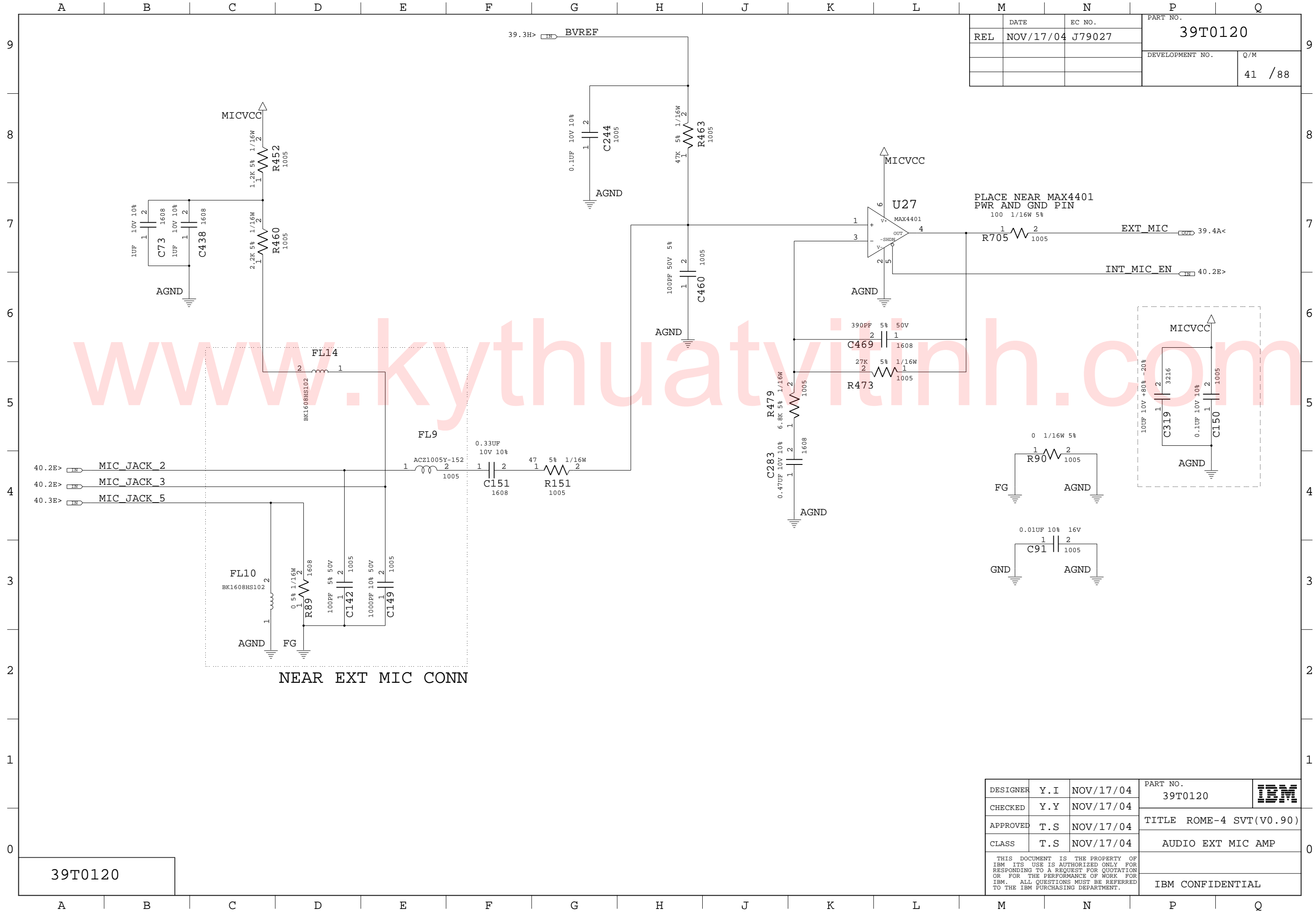

PLACE NEAR MAX4401  
PWR AND GND PIN  
100 1/16W 5%

NEAR EXT MIC CONN

39T0120

DESIGNER	Y.I	NOV/17/04	PART NO.	39T0120	
CHECKED	Y.Y	NOV/17/04			
APPROVED	T.S	NOV/17/04	TITLE ROME-4 SVT(V0.90)		
CLASS	T.S	NOV/17/04	AUDIO EXT MIC AMP		
THIS DOCUMENT IS THE PROPERTY OF IBM ITS USE IS AUTHORIZED ONLY FOR RESPONDING TO A REQUEST FOR QUOTATION OR FOR THE PERFORMANCE OF WORK FOR IBM. ALL QUESTIONS MUST BE REFERRED TO THE IBM PURCHASING DEPARTMENT.				IBM CONFIDENTIAL	

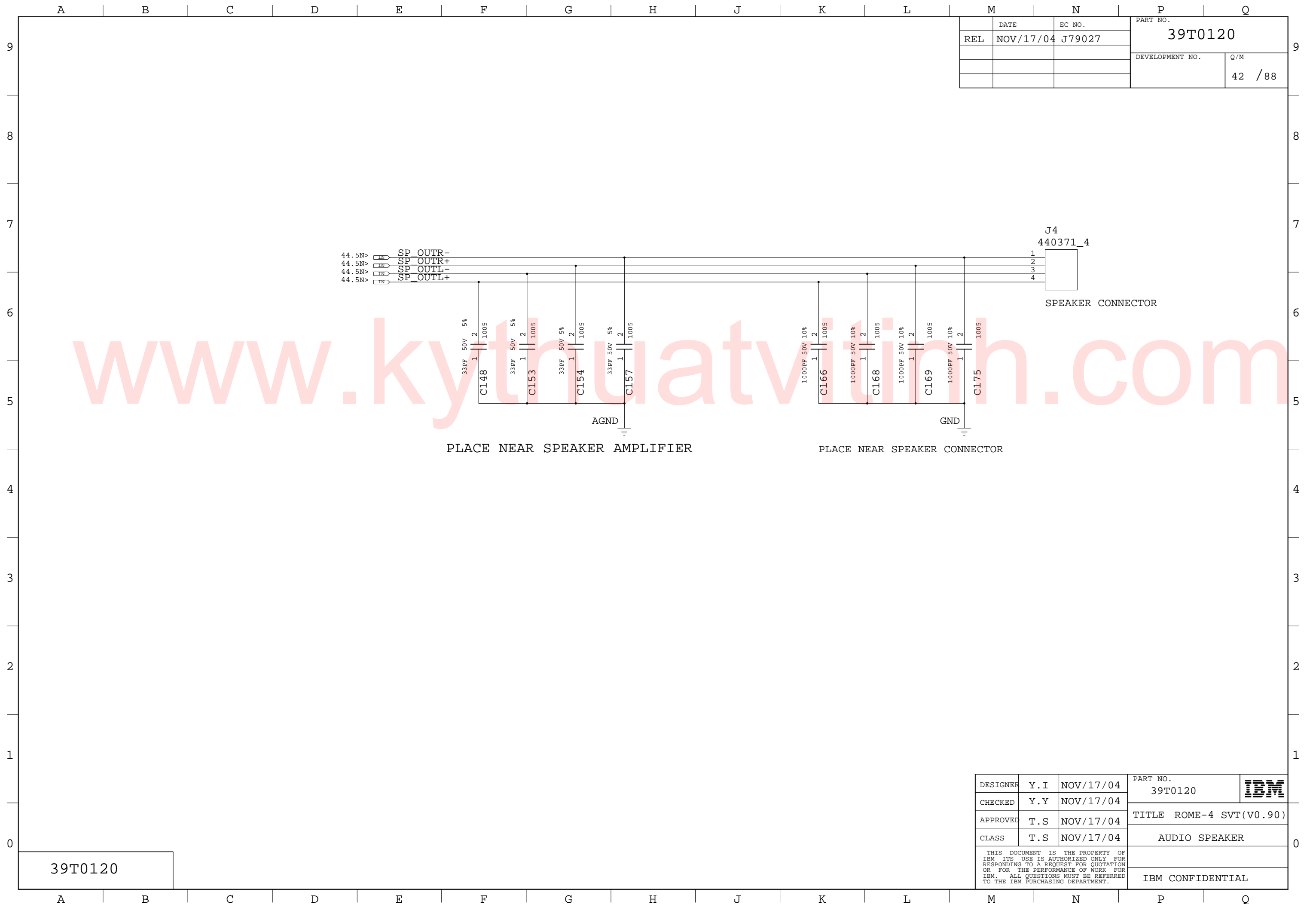

	DATE	EC NO.	PART NO.	
REL	NOV/17/04	J79027	39T0120	
			DEVELOPMENT NO.	Q/M
				42 / 88

39T0120

DESIGNER	Y. I	NOV/17/04	PART NO.	39T0120	<b>IBM</b>
CHECKED	Y. Y	NOV/17/04			
APPROVED	T. S	NOV/17/04	TITLE ROME-4 SVT(V0.90)		
CLASS	T. S	NOV/17/04	AUDIO SPEAKER		
THIS DOCUMENT IS THE PROPERTY OF IBM ITS USE IS AUTHORIZED ONLY FOR RESPONDING TO A REQUEST FOR QUOTATION OR FOR THE PERFORMANCE OF WORK FOR IBM. ALL QUESTIONS MUST BE REFERRED TO THE IBM PURCHASING DEPARTMENT.				IBM CONFIDENTIAL	

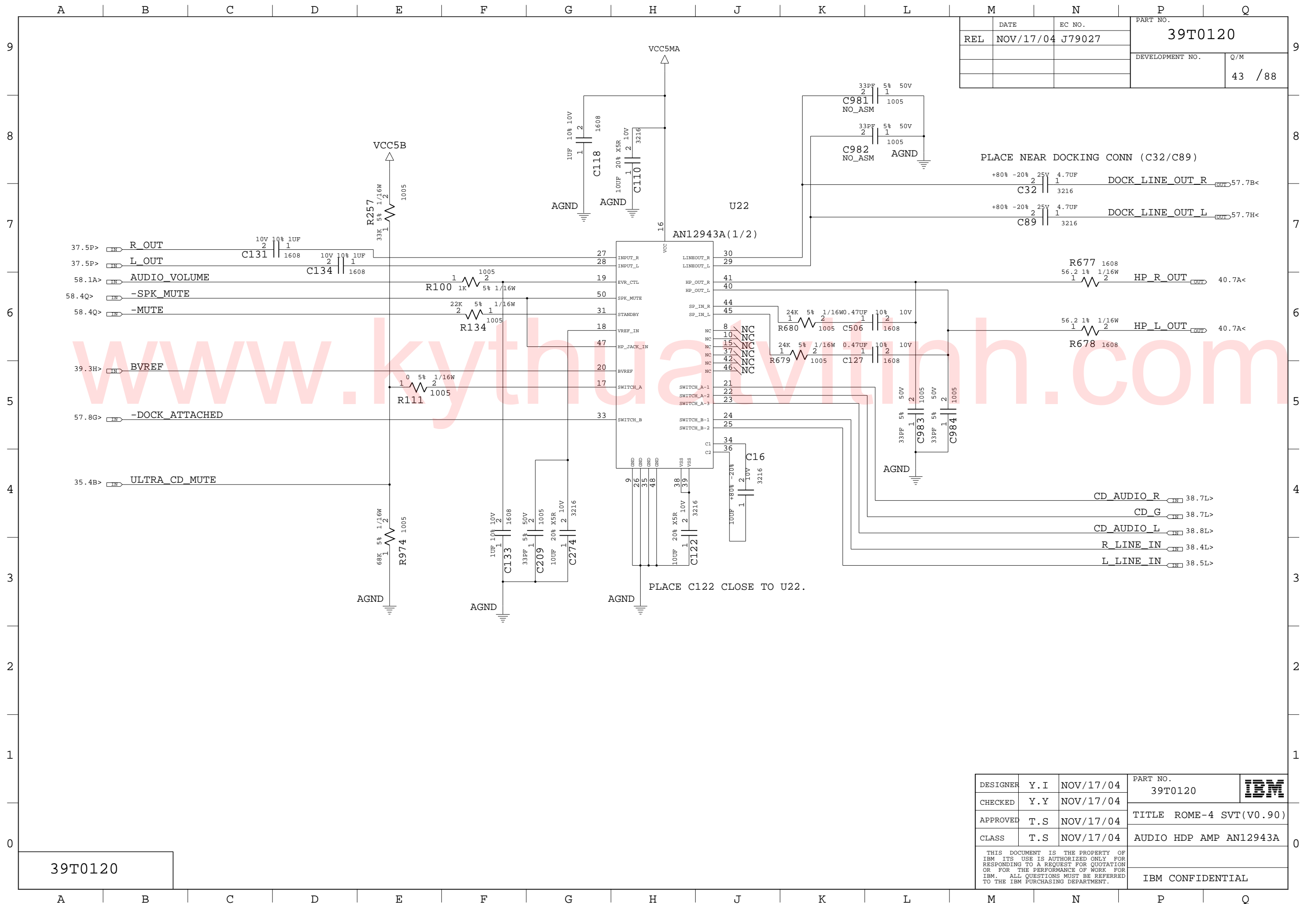

DATE	NOV/17/04	EC NO.	J79027	PART NO.	39T0120
REL				DEVELOPMENT NO.	Q/M
					43 / 88

PLACE NEAR DOCKING CONN (C32/C89)

+80% -20% 25V 4.7UF DOCK LINE OUT R (OUT) 57.7B<

+80% -20% 25V 4.7UF DOCK LINE OUT L (OUT) 57.7H<

HP R OUT (OUT) 40.7A<

HP L OUT (OUT) 40.7A<

CD AUDIO R (IN) 38.7L>

CD G (IN) 38.7L>

CD AUDIO L (IN) 38.8L>

R LINE IN (IN) 38.4L>

L LINE IN (IN) 38.5L>

PLACE C122 CLOSE TO U22.

39T0120

DESIGNER	Y.I	NOV/17/04	PART NO.	39T0120	
CHECKED	Y.Y	NOV/17/04	TITLE	ROME-4 SVT(V0.90)	
APPROVED	T.S	NOV/17/04	CLASS	AUDIO HDP AMP AN12943A	
THIS DOCUMENT IS THE PROPERTY OF IBM ITS USE IS AUTHORIZED ONLY FOR RESPONDING TO A REQUEST FOR QUOTATION OR FOR THE PERFORMANCE OF WORK FOR IBM. ALL QUESTIONS MUST BE REFERRED TO THE IBM PURCHASING DEPARTMENT.					IBM CONFIDENTIAL

	DATE	EC NO.	PART NO.	
REL	NOV/17/04	J79027	39T0120	
			DEVELOPMENT NO.	Q/M
				44 / 88

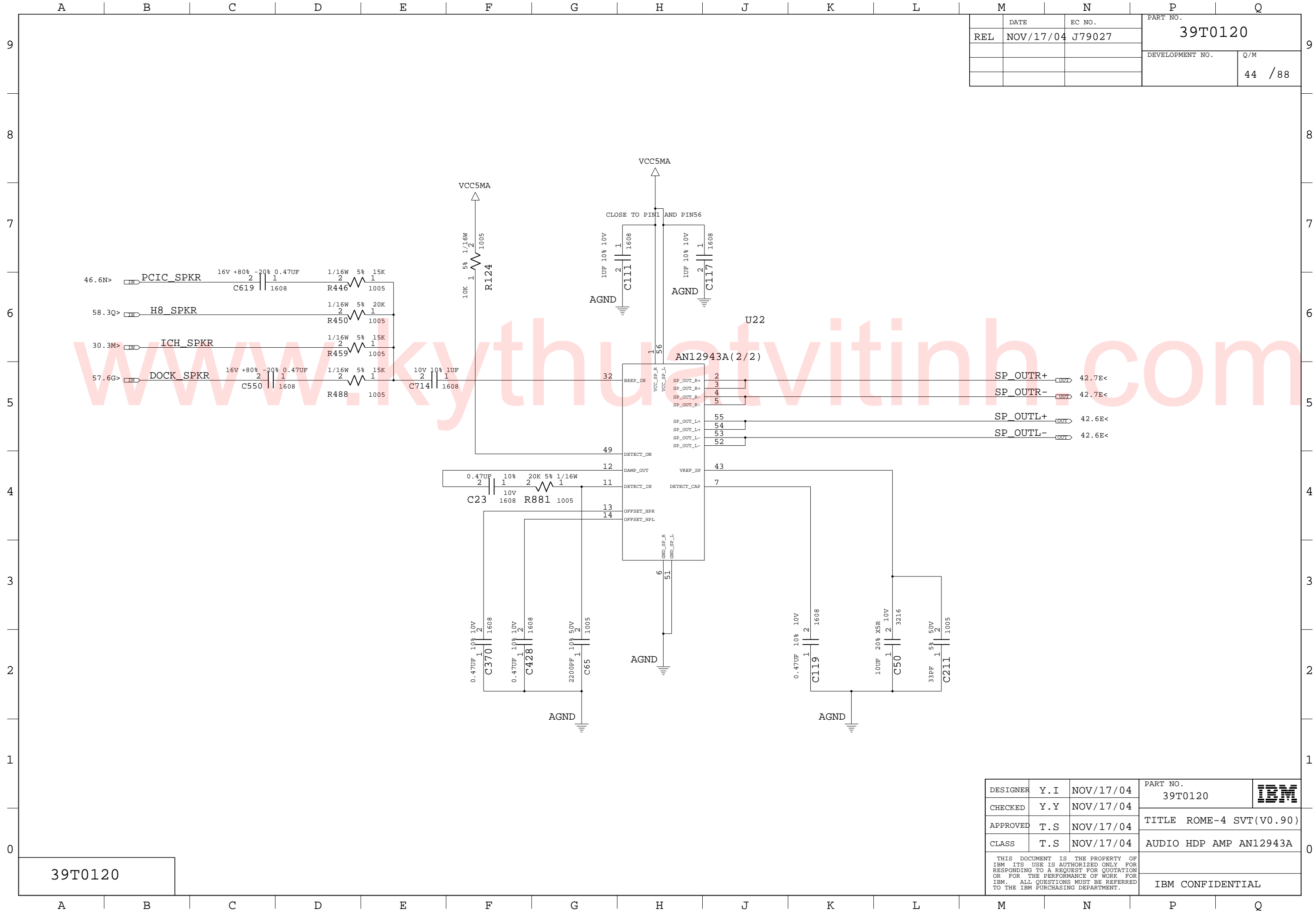

39T0120

DESIGNER	Y.I	NOV/17/04	PART NO.	39T0120	IBM
CHECKED	Y.Y	NOV/17/04			
APPROVED	T.S	NOV/17/04	TITLE ROME-4 SVT(V0.90)		
CLASS	T.S	NOV/17/04	AUDIO HDP AMP AN12943A		
THIS DOCUMENT IS THE PROPERTY OF IBM ITS USE IS AUTHORIZED ONLY FOR RESPONDING TO A REQUEST FOR QUOTATION OR FOR THE PERFORMANCE OF WORK FOR IBM. ALL QUESTIONS MUST BE REFERRED TO THE IBM PURCHASING DEPARTMENT.					IBM CONFIDENTIAL



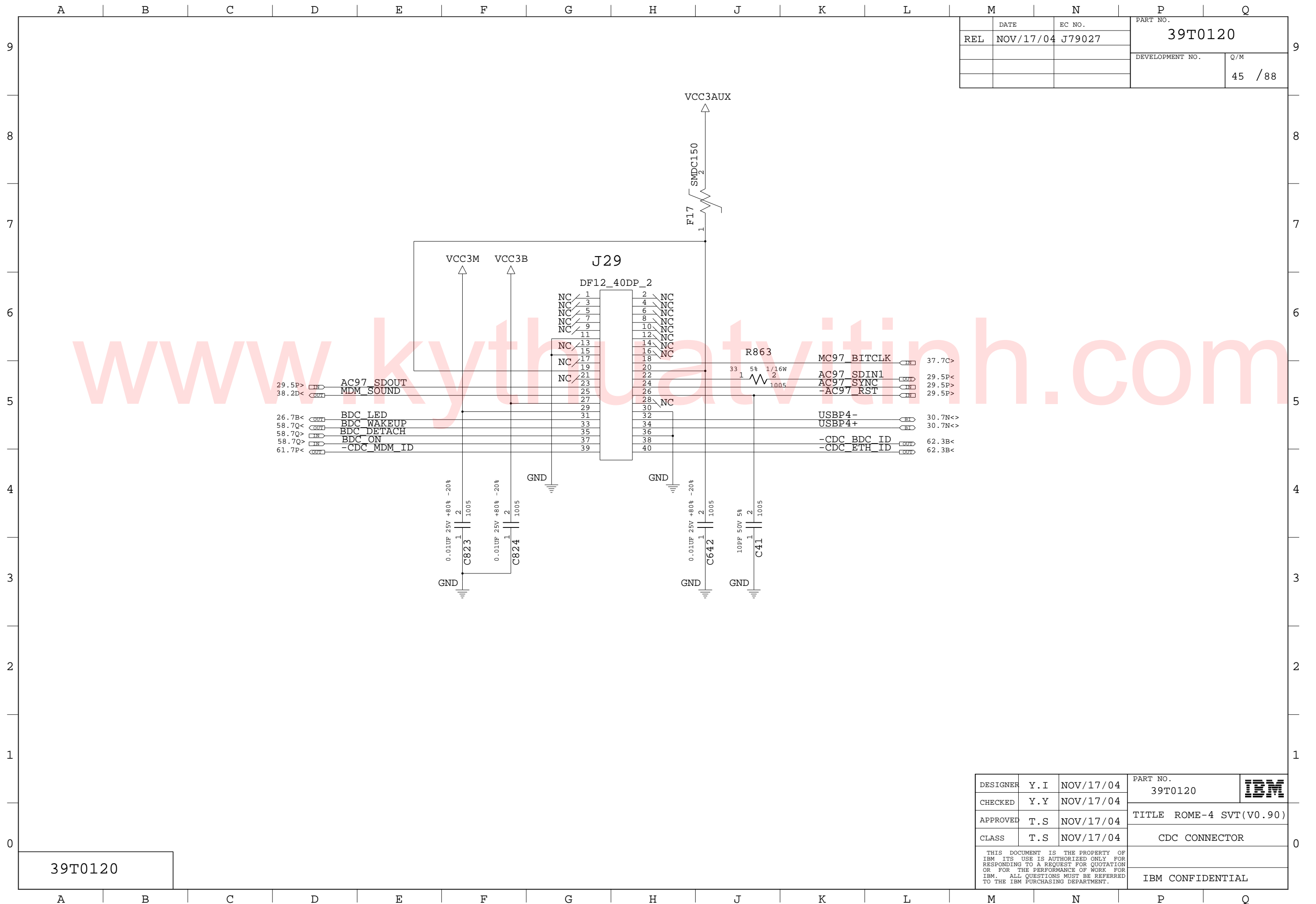

	DATE	EC NO.	PART NO.	
REL	NOV/17/04	J79027	39T0120	
			DEVELOPMENT NO.	Q/M
				45 / 88

39T0120

DESIGNER	Y.I	NOV/17/04	PART NO.	39T0120	
CHECKED	Y.Y	NOV/17/04			
APPROVED	T.S	NOV/17/04	TITLE ROME-4 SVT(V0.90)		
CLASS	T.S	NOV/17/04	CDC CONNECTOR		
THIS DOCUMENT IS THE PROPERTY OF IBM. ITS USE IS AUTHORIZED ONLY FOR RESPONDING TO A REQUEST FOR QUOTATION OR FOR THE PERFORMANCE OF WORK FOR IBM. ALL QUESTIONS MUST BE REFERRED TO THE IBM PURCHASING DEPARTMENT.					IBM CONFIDENTIAL

REL	DATE	EC NO.	PART NO.
	NOV/17/04	J79027	39T0120
			DEVELOPMENT NO.
			Q/M
			46 / 88

TABLE 1394 1/1

	N-1394	Y-1394
U20	R5C821	R5C851
FL6	NO-ASM	ASM
C943	NO-ASM	ASM
C945	NO-ASM	ASM
R399	NO-ASM	ASM
C942	NO-ASM	ASM
R944	NO-ASM	ASM
C256	NO-ASM	ASM
R946	NO-ASM	ASM
R947	NO-ASM	ASM
R949	NO-ASM	ASM
R950	NO-ASM	ASM
C949	NO-ASM	ASM
R948	NO-ASM	ASM
C946	NO-ASM	ASM
C951	NO-ASM	ASM
J20	NO-ASM	ASM
C944	NO-ASM	ASM
R945	NO-ASM	ASM
Y7	NO-ASM	ASM
C947	NO-ASM	ASM
C948	NO-ASM	ASM
R948	NO-ASM	ASM

LOGIC

PAGE 62

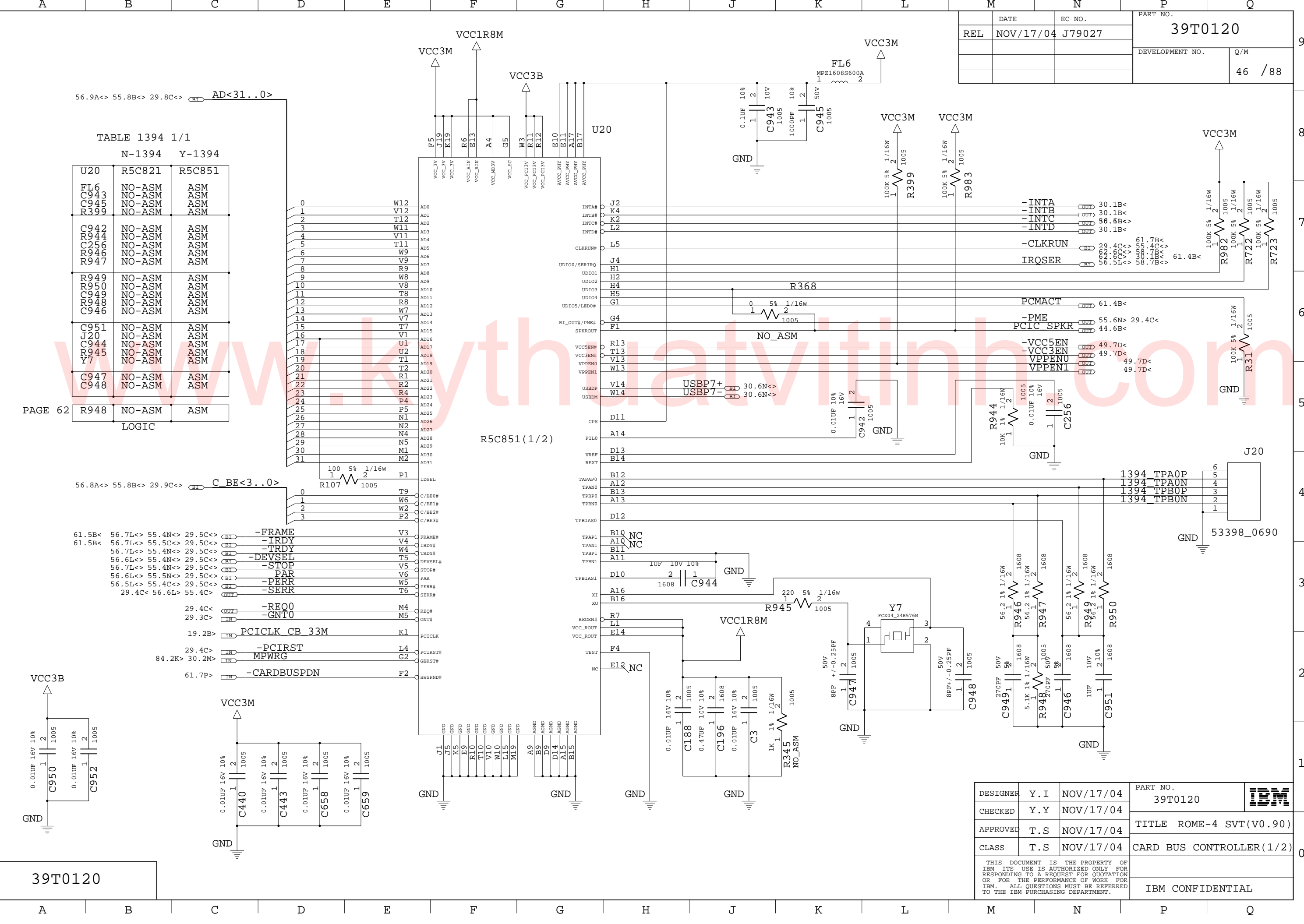

TABLE 1394 2/1

	N-1394	Y-1394
U20	R5C821	R5C851
FL6	NO-ASM	ASM
C943	NO-ASM	ASM
C945	NO-ASM	ASM
R399	NO-ASM	ASM
C942	NO-ASM	ASM
R944	NO-ASM	ASM
C256	NO-ASM	ASM
R946	NO-ASM	ASM
R947	NO-ASM	ASM
R949	NO-ASM	ASM
R950	NO-ASM	ASM
C949	NO-ASM	ASM
R948	NO-ASM	ASM
C946	NO-ASM	ASM
C951	NO-ASM	ASM
J20	NO-ASM	ASM
C944	NO-ASM	ASM
R945	NO-ASM	ASM
Y7	NO-ASM	ASM
C947	NO-ASM	ASM
C948	NO-ASM	ASM
R948	NO-ASM	ASM

LOGIC

TABLE 1394 3/1

	N-1394	Y-1394
U20	R5C821	R5C851
FL6	NO-ASM	ASM
C943	NO-ASM	ASM
C945	NO-ASM	ASM
R399	NO-ASM	ASM
C942	NO-ASM	ASM
R944	NO-ASM	ASM
C256	NO-ASM	ASM
R946	NO-ASM	ASM
R947	NO-ASM	ASM
R949	NO-ASM	ASM
R950	NO-ASM	ASM
C949	NO-ASM	ASM
R948	NO-ASM	ASM
C946	NO-ASM	ASM
C951	NO-ASM	ASM
J20	NO-ASM	ASM
C944	NO-ASM	ASM
R945	NO-ASM	ASM
Y7	NO-ASM	ASM
C947	NO-ASM	ASM
C948	NO-ASM	ASM
R948	NO-ASM	ASM

LOGIC

39T0120

DESIGNER	Y.I	NOV/17/04	PART NO.	39T0120	
CHECKED	Y.Y	NOV/17/04	TITLE	ROME-4 SVT(V0.90)	
APPROVED	T.S	NOV/17/04	CLASS	CARD BUS CONTROLLER(1/2)	
CLASS	T.S	NOV/17/04	THIS DOCUMENT IS THE PROPERTY OF IBM ITS USE IS AUTHORIZED ONLY FOR RESPONDING TO A REQUEST FOR QUOTATION OR FOR THE PERFORMANCE OF WORK FOR IBM. ALL QUESTIONS MUST BE REFERRED TO THE IBM PURCHASING DEPARTMENT.		
					IBM CONFIDENTIAL

REL	DATE NOV/17/04	EC NO. J79027	PART NO. 39T0120
			DEVELOPMENT NO. Q/M 47 / 88

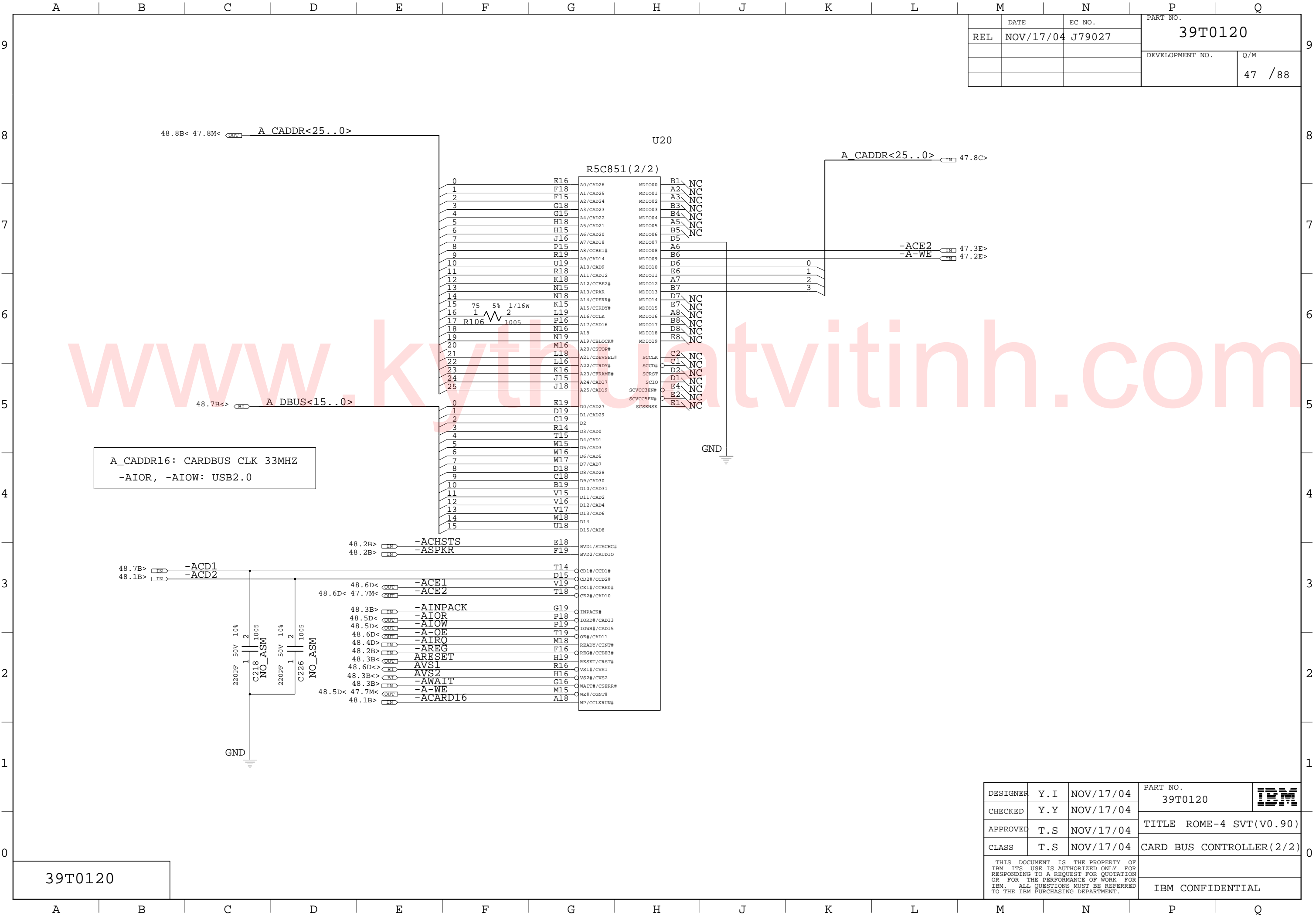

A\_CADDR16: CARDBUS CLK 33MHZ  
-AIOR, -AIOW: USB2.0

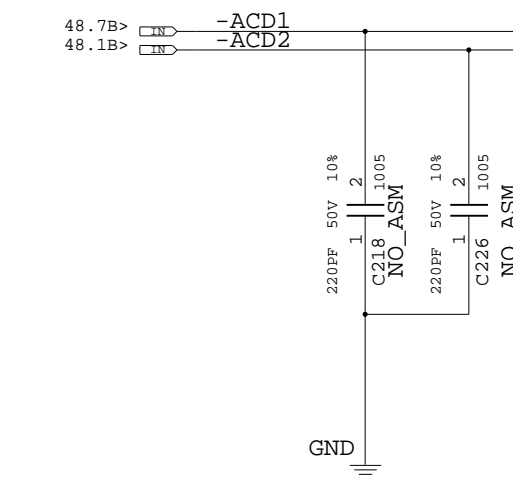

- 48.2B> -ACHSTS E18
- 48.2B> -ASPKR F19
- 48.6D< -ACE1 D15
- 47.7M< -ACE2 V19
- 48.3B> -AINPACK G19
- 48.5D< -AIOR P18
- 48.5D< -AIOW P19
- 48.6D< -A-OE T19
- 48.4D> -AIRO M18
- 48.2B> -AREG F16
- 48.3B> -ARESET H19
- 48.6D< AVS1 R16
- 48.3B> AVS2 H16
- 48.3B> -AWAIT G16
- 47.7M< -A-WE M15
- 48.1B> -ACARD16 A18

39T0120

DESIGNER	Y.I	NOV/17/04	PART NO. 39T0120	
CHECKED	Y.Y	NOV/17/04	TITLE ROME-4 SVT(V0.90)	
APPROVED	T.S	NOV/17/04	CLASS CARD BUS CONTROLLER(2/2)	
THIS DOCUMENT IS THE PROPERTY OF IBM. ITS USE IS AUTHORIZED ONLY FOR RESPONDING TO A REQUEST FOR QUOTATION OR FOR THE PERFORMANCE OF WORK FOR IBM. ALL QUESTIONS MUST BE REFERRED TO THE IBM PURCHASING DEPARTMENT.				IBM CONFIDENTIAL

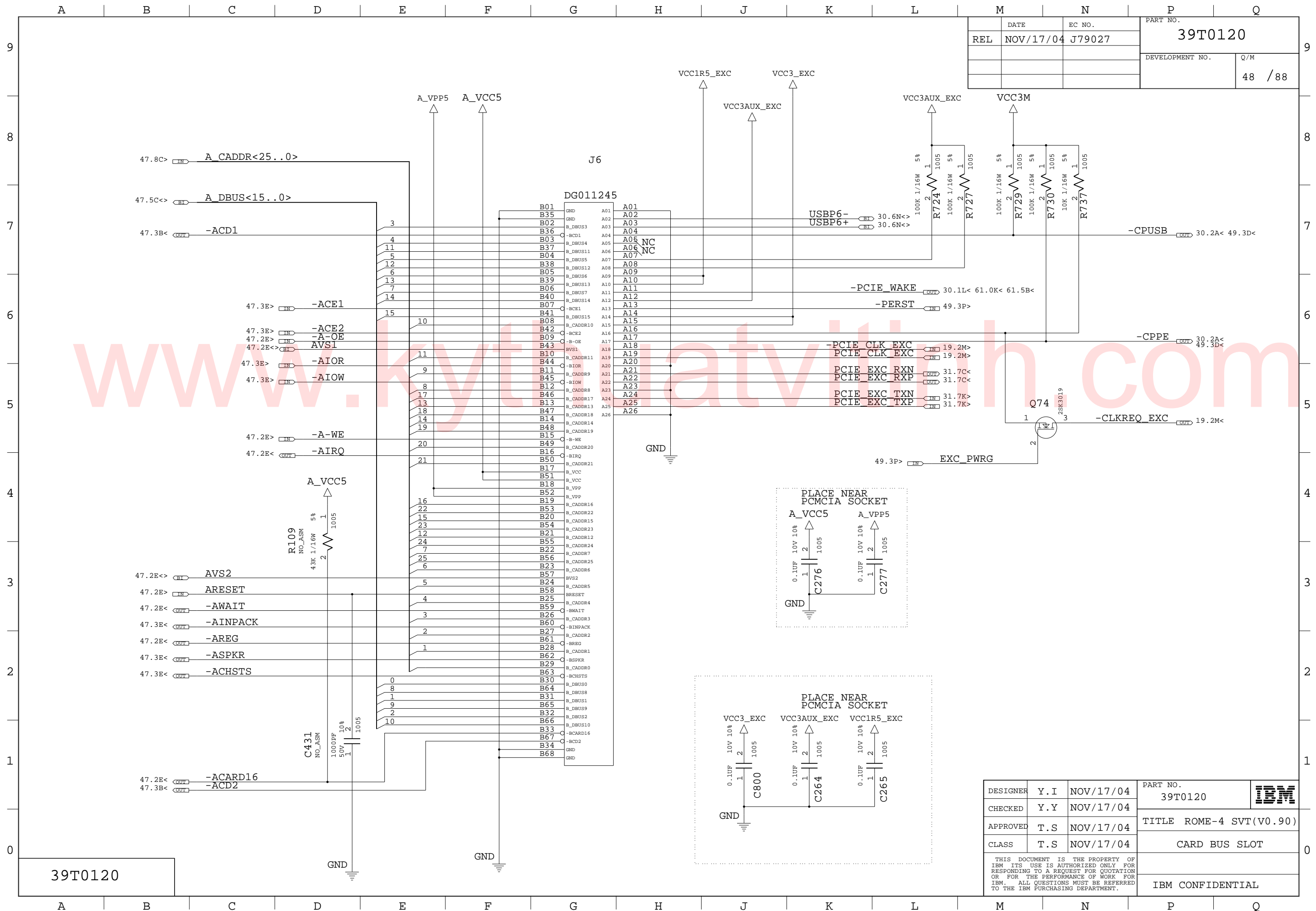

REL	DATE	EC NO.	PART NO.
	NOV/17/04	J79027	39T0120
			DEVELOPMENT NO.
			Q/M
			48 / 88

DESIGNER	Y.I	NOV/17/04	PART NO.	39T0120	IBM
CHECKED	Y.Y	NOV/17/04			
APPROVED	T.S	NOV/17/04	TITLE ROME-4 SVT(V0.90)		
CLASS	T.S	NOV/17/04	CARD BUS SLOT		
THIS DOCUMENT IS THE PROPERTY OF IBM. ITS USE IS AUTHORIZED ONLY FOR RESPONDING TO A REQUEST FOR QUOTATION OR FOR THE PERFORMANCE OF WORK FOR IBM. ALL QUESTIONS MUST BE REFERRED TO THE IBM PURCHASING DEPARTMENT.					IBM CONFIDENTIAL

39T0120

DATE	NOV/17/04	EC NO.	J79027	PART NO.	39T0120
REL				DEVELOPMENT NO.	49 / 88
				Q/M	

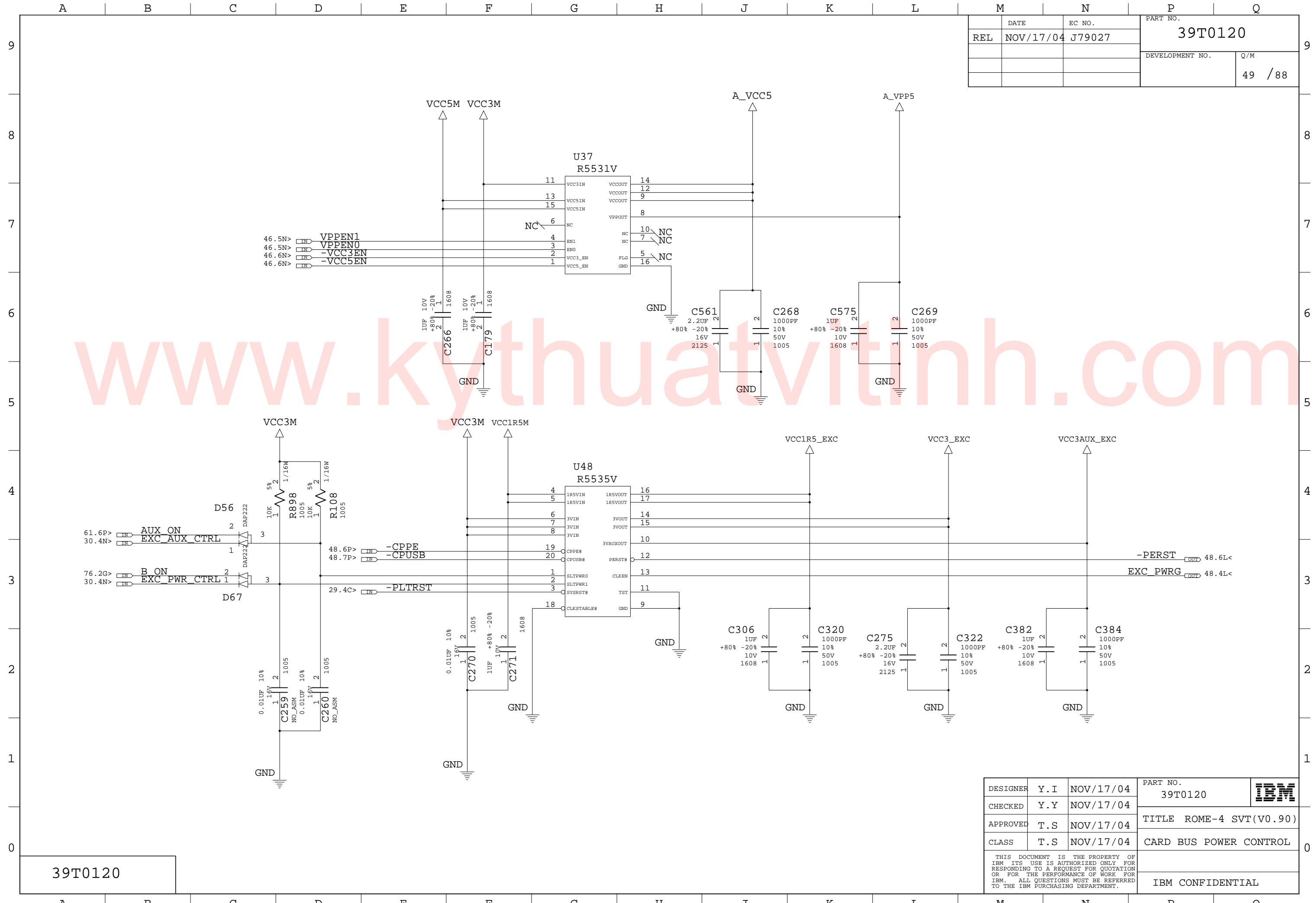

39T0120

DESIGNER	Y.I	NOV/17/04	PART NO.	39T0120	<b>IBM</b>
CHECKED	Y.Y	NOV/17/04			
APPROVED	T.S	NOV/17/04	TITLE		ROME-4 SVT(V0.90)
CLASS	T.S	NOV/17/04	CARD BUS POWER CONTROL		
THIS DOCUMENT IS THE PROPERTY OF IBM ITS USE IS AUTHORIZED ONLY FOR RESPONDING TO A REQUEST FOR QUOTATION OR FOR THE PERFORMANCE OF WORK FOR IBM. ALL QUESTIONS MUST BE REFERRED TO THE IBM PURCHASING DEPARTMENT.					IBM CONFIDENTIAL





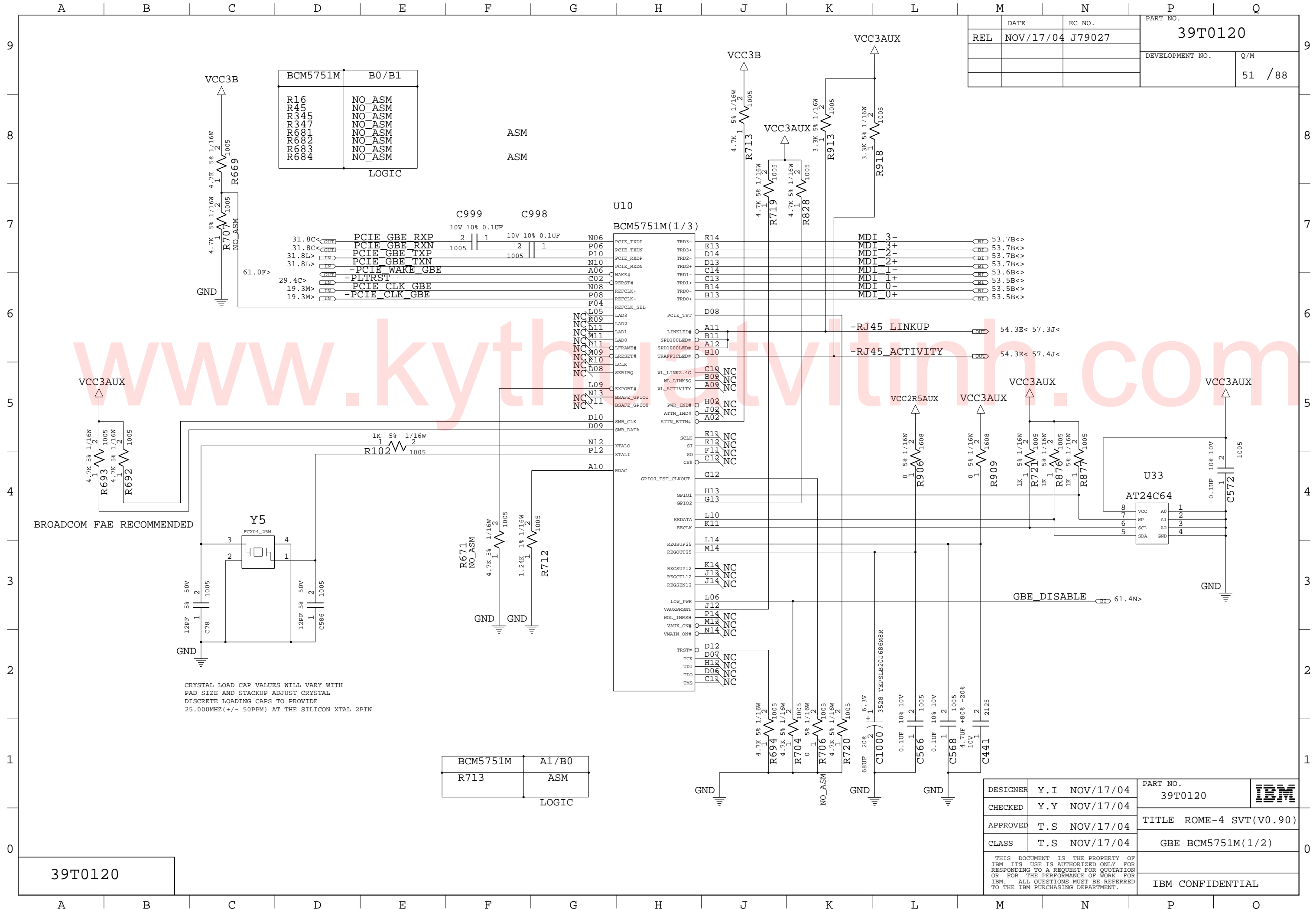

REL	DATE	EC NO.	PART NO.
	NOV/17/04	J79027	39T0120
			DEVELOPMENT NO.
			Q/M
			51 / 88

BCM5751M	B0/B1
R16	NO_ASM
R45	NO_ASM
R345	NO_ASM
R347	NO_ASM
R681	NO_ASM
R682	NO_ASM
R683	NO_ASM
R684	NO_ASM
LOGIC	

BCM5751M	A1/B0
R713	ASM
LOGIC	

CRYSTAL LOAD CAP VALUES WILL VARY WITH PAD SIZE AND STACKUP ADJUST CRYSTAL DISCRETE LOADING CAPS TO PROVIDE 25.000MHZ(+/- 50PPM) AT THE SILICON XTAL 2PIN

BROADCOM FAE RECOMMENDED

39T0120

DESIGNER	Y.I	NOV/17/04	PART NO.	39T0120	IBM
CHECKED	Y.Y	NOV/17/04	TITLE		
APPROVED	T.S	NOV/17/04	CLASS	GBE BCM5751M(1/2)	
THIS DOCUMENT IS THE PROPERTY OF IBM. ITS USE IS AUTHORIZED ONLY FOR RESPONDING TO A REQUEST FOR QUOTATION OR FOR THE PERFORMANCE OF WORK FOR IBM. ALL QUESTIONS MUST BE REFERRED TO THE IBM PURCHASING DEPARTMENT.				IBM CONFIDENTIAL	

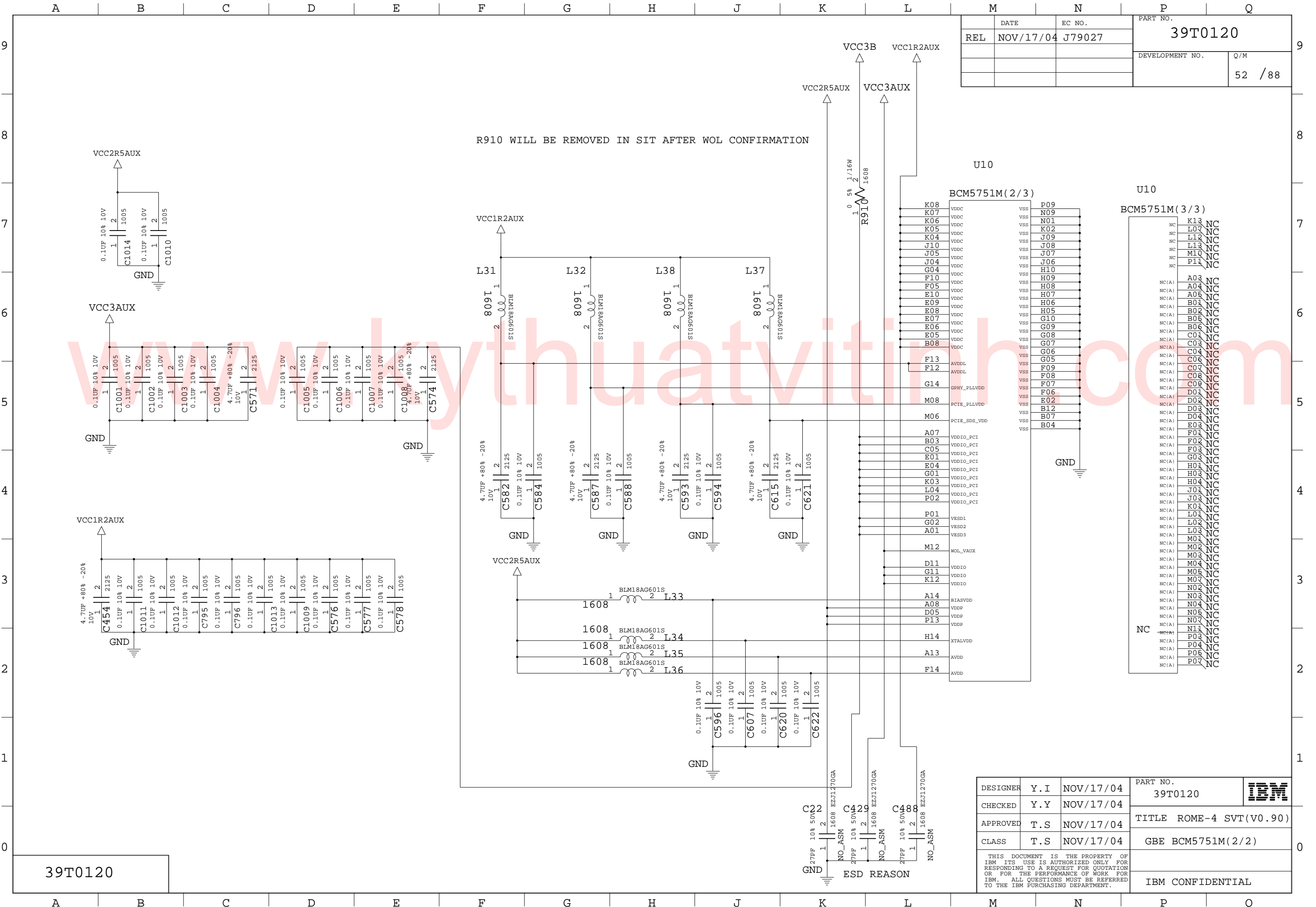

DATE	NOV/17/04	EC NO.	J79027	PART NO.	39T0120
REL				DEVELOPMENT NO.	Q/M
					52 / 88

U10 BCM5751M(2/3)

K08	VDDC	VSS	P09
K07	VDDC	VSS	N09
K06	VDDC	VSS	N01
K05	VDDC	VSS	K02
K04	VDDC	VSS	J09
J10	VDDC	VSS	J08
J05	VDDC	VSS	J07
J04	VDDC	VSS	J06
G04	VDDC	VSS	H10
F10	VDDC	VSS	H09
F05	VDDC	VSS	H08
E10	VDDC	VSS	H07
E09	VDDC	VSS	H06
E08	VDDC	VSS	H05
E07	VDDC	VSS	G10
E06	VDDC	VSS	G09
E05	VDDC	VSS	G08
B08	VDDC	VSS	G07
	VDDC	VSS	G06
	VDDC	VSS	G05
F13	AVDDL	VSS	F09
F12	AVDDL	VSS	F08
	PHY_PLLVDD	VSS	F07
	PHY_PLLVDD	VSS	F06
M08	PCIE_PLLVDD	VSS	E02
	PCIE_PLLVDD	VSS	D02
M06	PCIE_SDS_VDD	VSS	B12
	PCIE_SDS_VDD	VSS	B07
	PCIE_SDS_VDD	VSS	B04
	VSS	VSS	
A07	VDDIO_PCI	VSS	F01
B03	VDDIO_PCI	VSS	F02
C05	VDDIO_PCI	VSS	F03
E01	VDDIO_PCI	VSS	G03
E04	VDDIO_PCI	VSS	H01
G01	VDDIO_PCI	VSS	H03
L04	VDDIO_PCI	VSS	H04
P02	VDDIO_PCI	VSS	J01
	VDDIO_PCI	VSS	J03
	VDDIO_PCI	VSS	K01
P01	VESD1	VSS	L01
G02	VESD2	VSS	L02
A01	VESD3	VSS	L03
	VESD3	VSS	M01
M12	WOL_VAUX	VSS	M02
	WOL_VAUX	VSS	M03
	WOL_VAUX	VSS	M04
D11	VDDIO	VSS	M05
G11	VDDIO	VSS	M07
K12	VDDIO	VSS	M02
	VDDIO	VSS	N02
	VDDIO	VSS	N03
A14	BIASVDD	VSS	N04
A08	VDDP	VSS	N04
D05	VDDP	VSS	N05
P13	VDDP	VSS	N07
	VDDP	VSS	N07
	VDDP	VSS	N07
H14	XTALVDD	VSS	N11
A13	AVDD	VSS	P03
F14	AVDD	VSS	P04
	AVDD	VSS	P05
	AVDD	VSS	P07
	AVDD	VSS	P07

U10 BCM5751M(3/3)

NC	K13	NC
NC	L07	NC
NC	L12	NC
NC	L13	NC
NC	M10	NC
NC	P11	NC
NC(A)	A03	NC
NC(A)	A04	NC
NC(A)	A05	NC
NC(A)	B01	NC
NC(A)	B02	NC
NC(A)	B05	NC
NC(A)	B06	NC
NC(A)	C01	NC
NC(A)	C03	NC
NC(A)	C04	NC
NC(A)	C06	NC
NC(A)	C07	NC
NC(A)	C08	NC
NC(A)	C09	NC
NC(A)	D01	NC
NC(A)	D02	NC
NC(A)	D03	NC
NC(A)	D04	NC
NC(A)	E03	NC
NC(A)	F01	NC
NC(A)	F02	NC
NC(A)	F03	NC
NC(A)	G03	NC
NC(A)	H01	NC
NC(A)	H03	NC
NC(A)	H04	NC
NC(A)	J01	NC
NC(A)	J03	NC
NC(A)	K01	NC
NC(A)	L01	NC
NC(A)	L02	NC
NC(A)	L03	NC
NC(A)	M01	NC
NC(A)	M02	NC
NC(A)	M03	NC
NC(A)	M04	NC
NC(A)	M05	NC
NC(A)	M07	NC
NC(A)	N02	NC
NC(A)	N03	NC
NC(A)	N04	NC
NC(A)	N05	NC
NC(A)	N07	NC
NC(A)	N11	NC
NC(A)	P03	NC
NC(A)	P04	NC
NC(A)	P05	NC
NC(A)	P07	NC

DESIGNER	Y.I	NOV/17/04	PART NO.	39T0120	
CHECKED	Y.Y	NOV/17/04	TITLE	ROME-4 SVT(V0.90)	
APPROVED	T.S	NOV/17/04	CLASS	GBE BCM5751M(2/2)	
THIS DOCUMENT IS THE PROPERTY OF IBM. ITS USE IS AUTHORIZED ONLY FOR RESPONDING TO A REQUEST FOR QUOTATION OR FOR THE PERFORMANCE OF WORK FOR IBM. ALL QUESTIONS MUST BE REFERRED TO THE IBM PURCHASING DEPARTMENT.				IBM CONFIDENTIAL	

39T0120

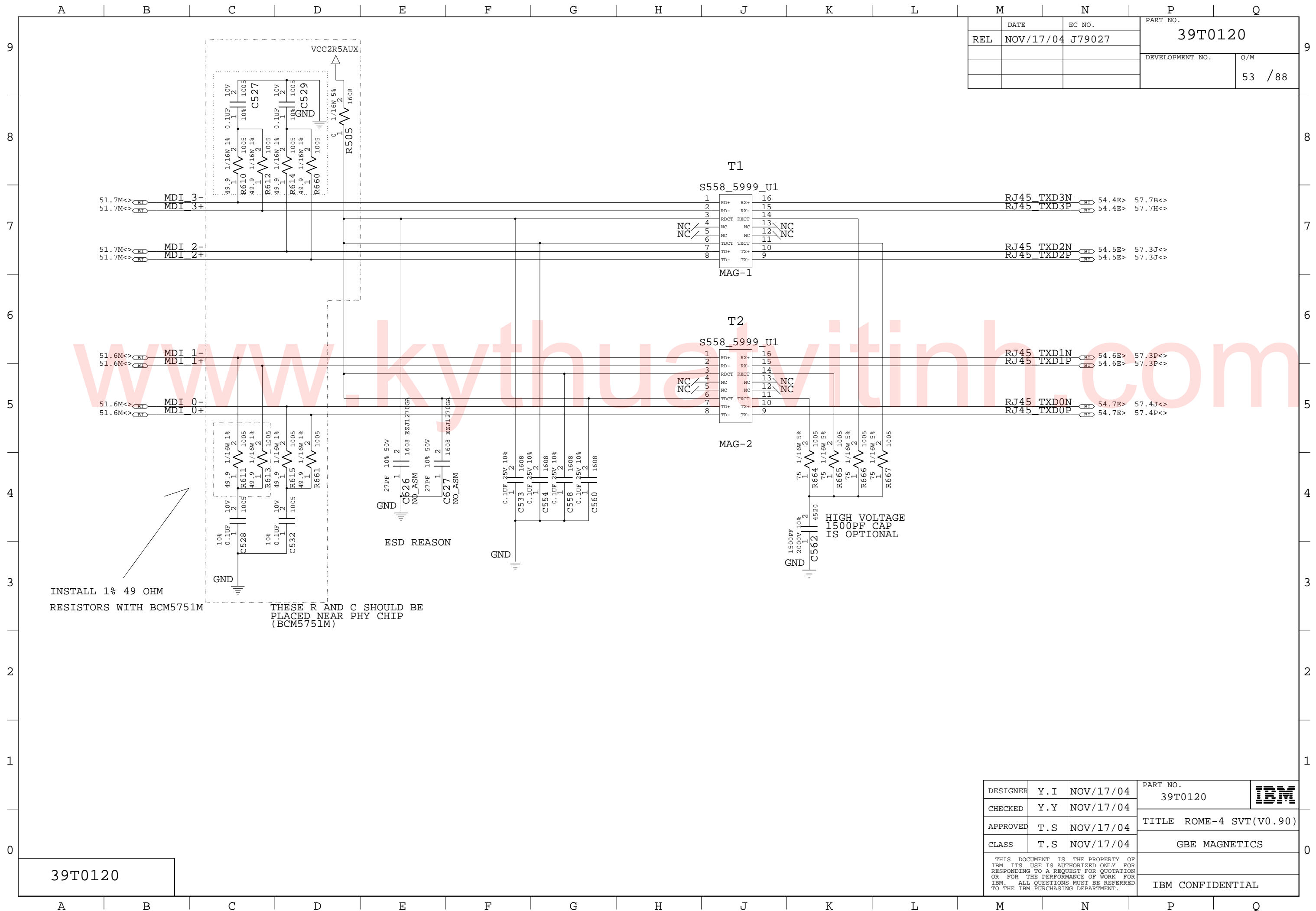

REL	DATE	EC NO.	PART NO.
	NOV/17/04	J79027	39T0120
			DEVELOPMENT NO.
			Q/M
			53 / 88

INSTALL 1% 49 OHM  
RESISTORS WITH BCM5751M

THESE R AND C SHOULD BE  
PLACED NEAR PHY CHIP  
(BCM5751M)

ESD REASON

HIGH VOLTAGE  
1500PF CAP  
IS OPTIONAL

39T0120

DESIGNER	Y.I	NOV/17/04	PART NO.	IBM
CHECKED	Y.Y	NOV/17/04	39T0120	
APPROVED	T.S	NOV/17/04	TITLE ROME-4 SVT(V0.90)	
CLASS	T.S	NOV/17/04	GBE MAGNETICS	
THIS DOCUMENT IS THE PROPERTY OF IBM ITS USE IS AUTHORIZED ONLY FOR RESPONDING TO A REQUEST FOR QUOTATION OR FOR THE PERFORMANCE OF WORK FOR IBM. ALL QUESTIONS MUST BE REFERRED TO THE IBM PURCHASING DEPARTMENT.				IBM CONFIDENTIAL

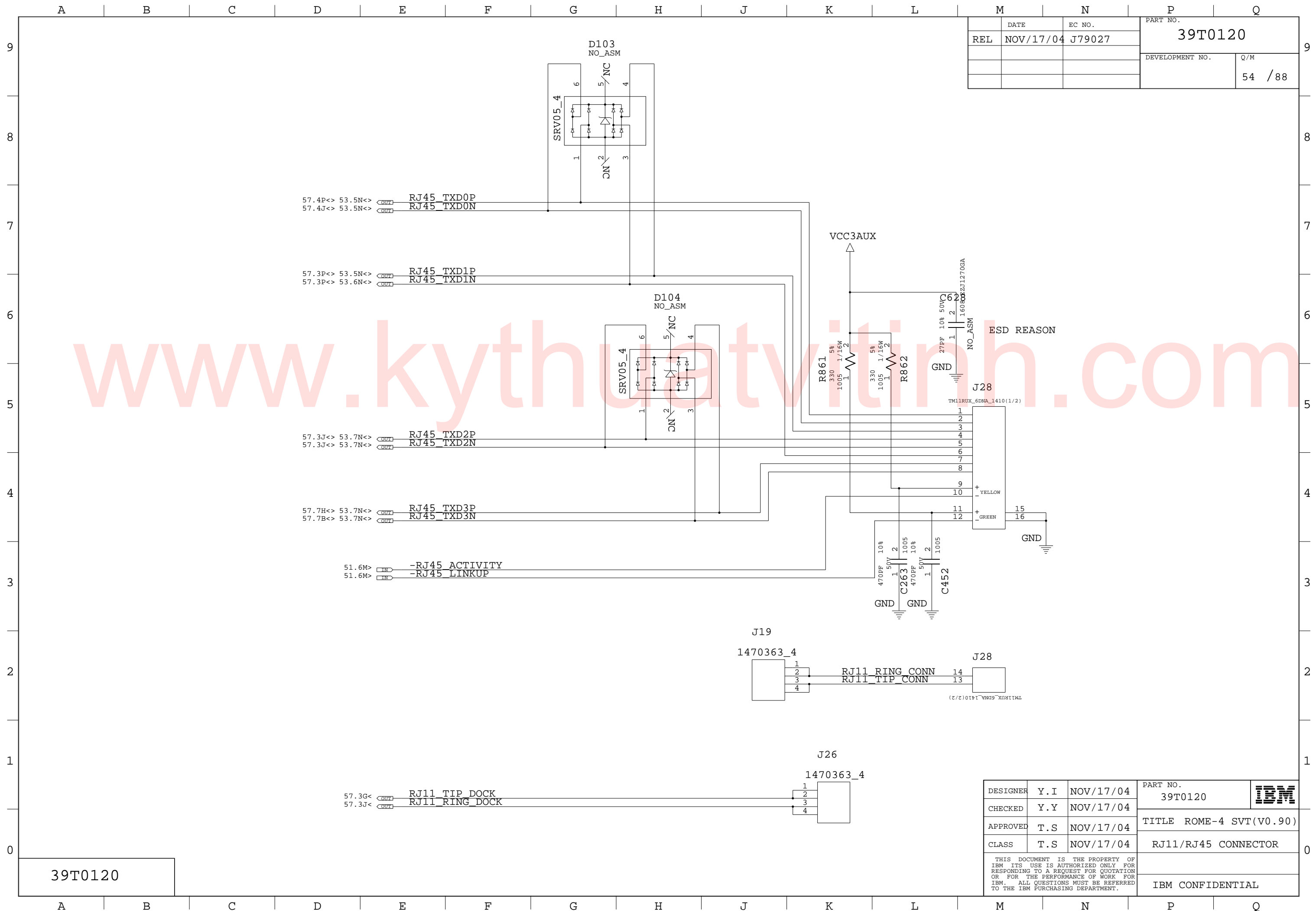

REL	DATE	EC NO.	PART NO.
	NOV/17/04	J79027	39T0120
			DEVELOPMENT NO.
			Q/M
			54 / 88

39T0120

DESIGNER	Y.I	NOV/17/04	PART NO.	IBM
CHECKED	Y.Y	NOV/17/04	39T0120	
APPROVED	T.S	NOV/17/04	TITLE ROME-4 SVT(V0.90)	
CLASS	T.S	NOV/17/04	RJ11/RJ45 CONNECTOR	
THIS DOCUMENT IS THE PROPERTY OF IBM. ITS USE IS AUTHORIZED ONLY FOR RESPONDING TO A REQUEST FOR QUOTATION OR FOR THE PERFORMANCE OF WORK FOR IBM. ALL QUESTIONS MUST BE REFERRED TO THE IBM PURCHASING DEPARTMENT.				IBM CONFIDENTIAL

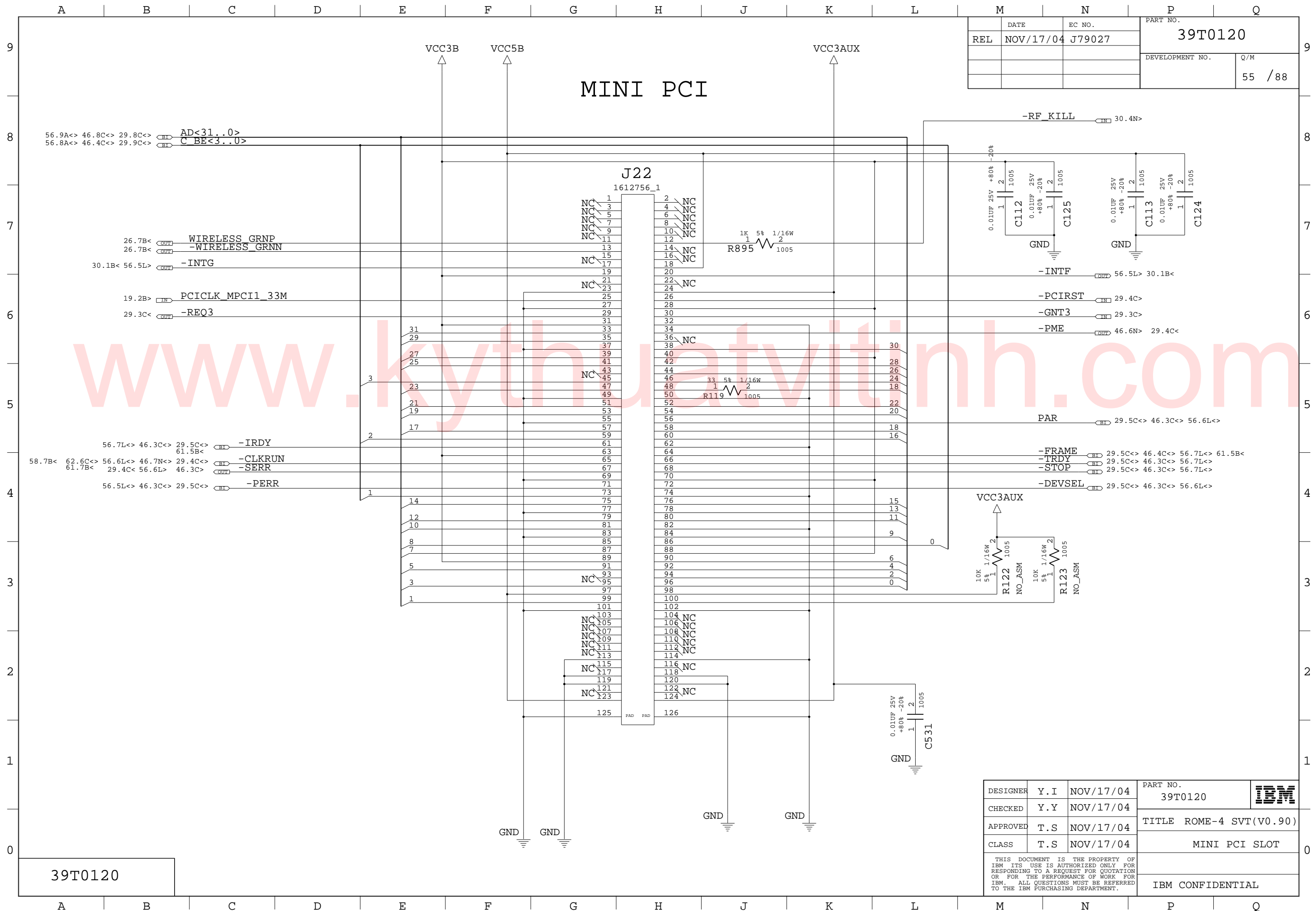

REL	DATE	EC NO.	PART NO.
	NOV/17/04	J79027	39T0120
			DEVELOPMENT NO.
			Q/M
			55 / 88

39T0120

DESIGNER	Y.I	NOV/17/04	PART NO.	39T0120	
CHECKED	Y.Y	NOV/17/04			
APPROVED	T.S	NOV/17/04	TITLE ROME-4 SVT(V0.90)		
CLASS	T.S	NOV/17/04	MINI PCI SLOT		
THIS DOCUMENT IS THE PROPERTY OF IBM ITS USE IS AUTHORIZED ONLY FOR RESPONDING TO A REQUEST FOR QUOTATION OR FOR THE PERFORMANCE OF WORK FOR IBM. ALL QUESTIONS MUST BE REFERRED TO THE IBM PURCHASING DEPARTMENT.					IBM CONFIDENTIAL

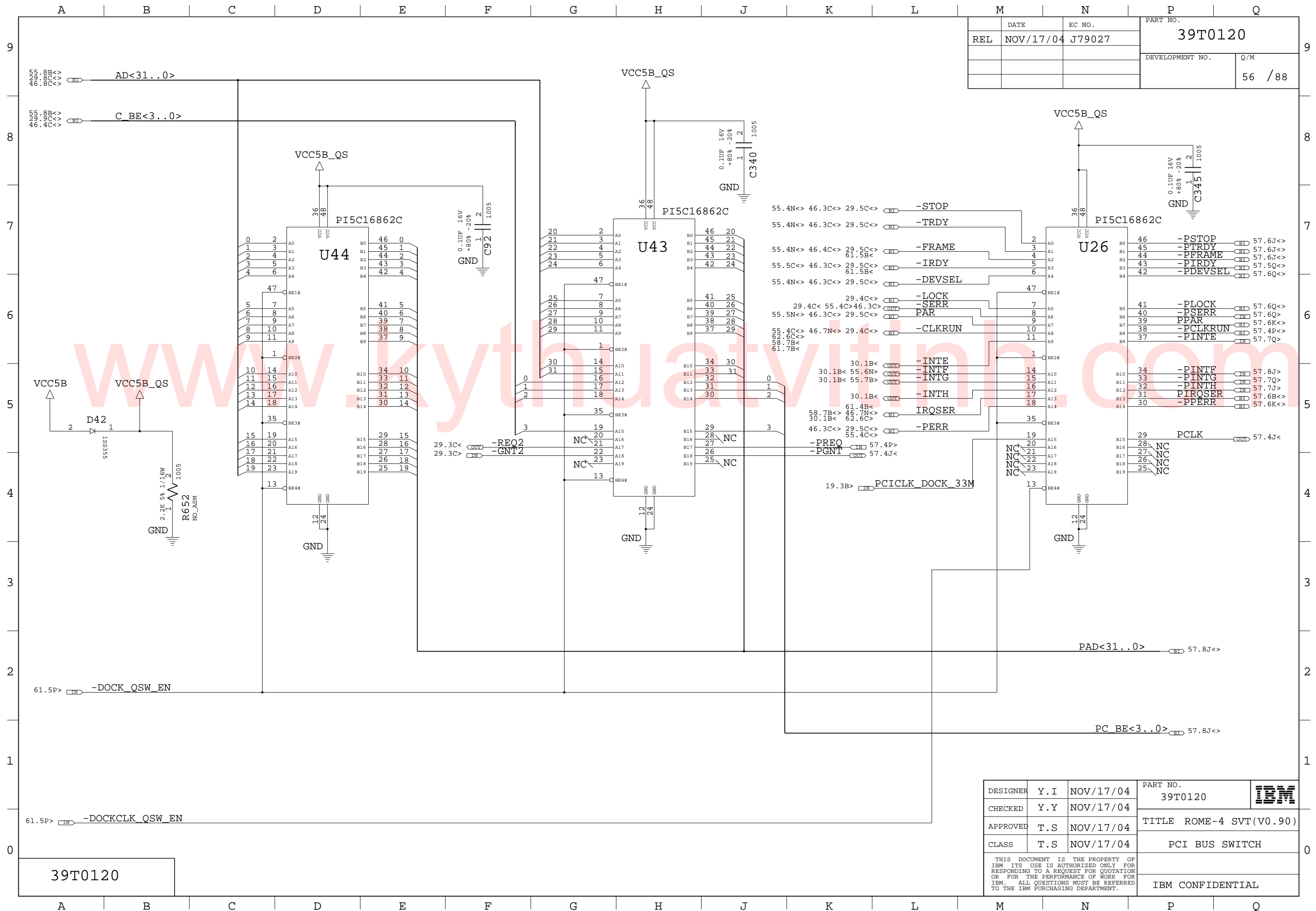

DATE	NOV/17/04	EC NO.	J79027	PART NO.	39T0120
REL				DEVELOPMENT NO.	56 / 88
				Q/M	

DESIGNER	Y.I	NOV/17/04	PART NO.	39T0120	<b>IBM</b>
CHECKED	Y.Y	NOV/17/04	TITLE ROME-4 SVT(V0.90)		
APPROVED	T.S	NOV/17/04	CLASS T.S NOV/17/04		PCI BUS SWITCH
THIS DOCUMENT IS THE PROPERTY OF IBM ITS USE IS AUTHORIZED ONLY FOR RESPONDING TO A REQUEST FOR QUOTATION OR FOR THE PERFORMANCE OF WORK FOR IBM. ALL QUESTIONS MUST BE REFERRED TO THE IBM PURCHASING DEPARTMENT.					IBM CONFIDENTIAL

39T0120



REL	DATE	EC NO.	PART NO.
	NOV/17/04	J79027	39T0120
			DEVELOPMENT NO. Q/M
			57 / 88

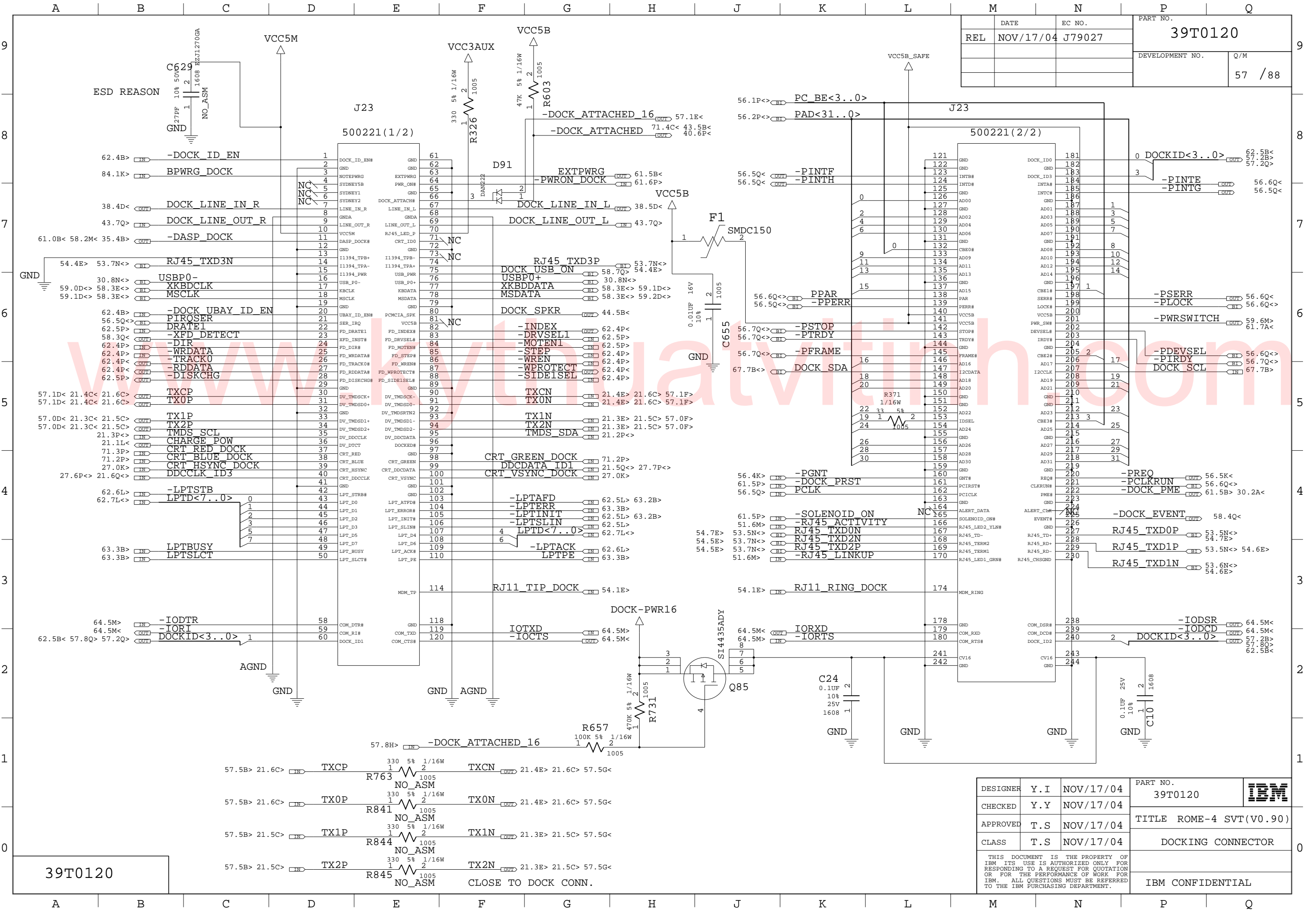

39T0120

DESIGNER	Y.I	NOV/17/04	PART NO.	39T0120	IBM
CHECKED	Y.Y	NOV/17/04	TITLE	ROME-4 SVT(V0.90)	
APPROVED	T.S	NOV/17/04	CLASS	DOCKING CONNECTOR	IBM CONFIDENTIAL
	T.S	NOV/17/04			

THIS DOCUMENT IS THE PROPERTY OF IBM ITS USE IS AUTHORIZED ONLY FOR RESPONDING TO A REQUEST FOR QUOTATION OR FOR THE PERFORMANCE OF WORK FOR IBM. ALL QUESTIONS MUST BE REFERRED TO THE IBM PURCHASING DEPARTMENT.

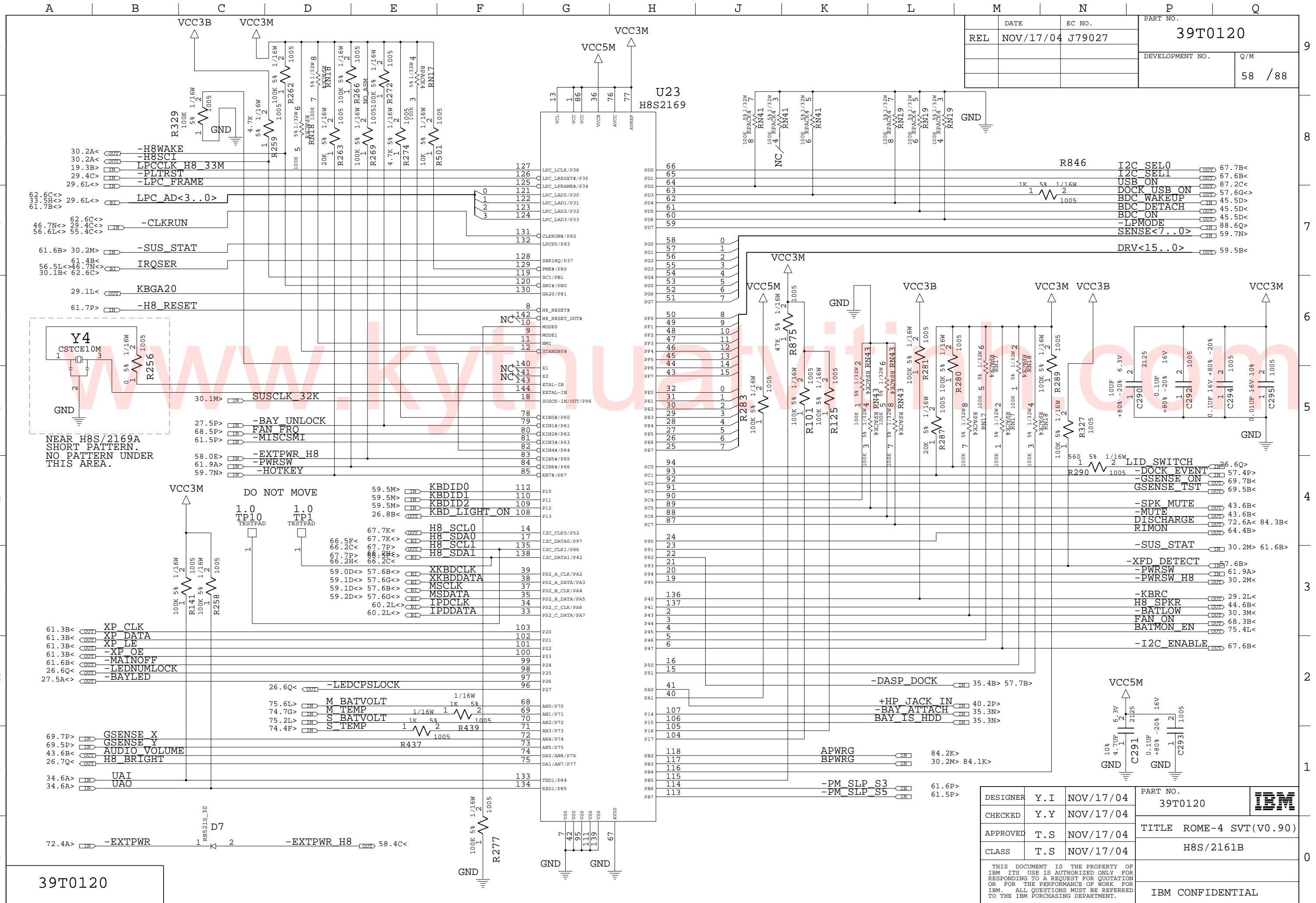

REL	NOV/17/04	J79027	PART NO.	39T0120
			DEVELOPMENT NO.	58 / 88

39T0120

DESIGNER	Y.I	NOV/17/04	PART NO.	39T0120	
CHECKED	Y.Y	NOV/17/04	TITLE	ROME-4 SVT(V0.90)	
APPROVED	T.S	NOV/17/04	CLASS	H8S/2161B	
THIS DOCUMENT IS THE PROPERTY OF IBM ITS USE IS AUTHORIZED ONLY FOR RESPONDING TO A REQUEST FOR QUOTATION OR FOR THE PERFORMANCE OF WORK FOR IBM. ALL QUESTIONS MUST BE REFERRED TO THE IBM PURCHASING DEPARTMENT.					IBM CONFIDENTIAL

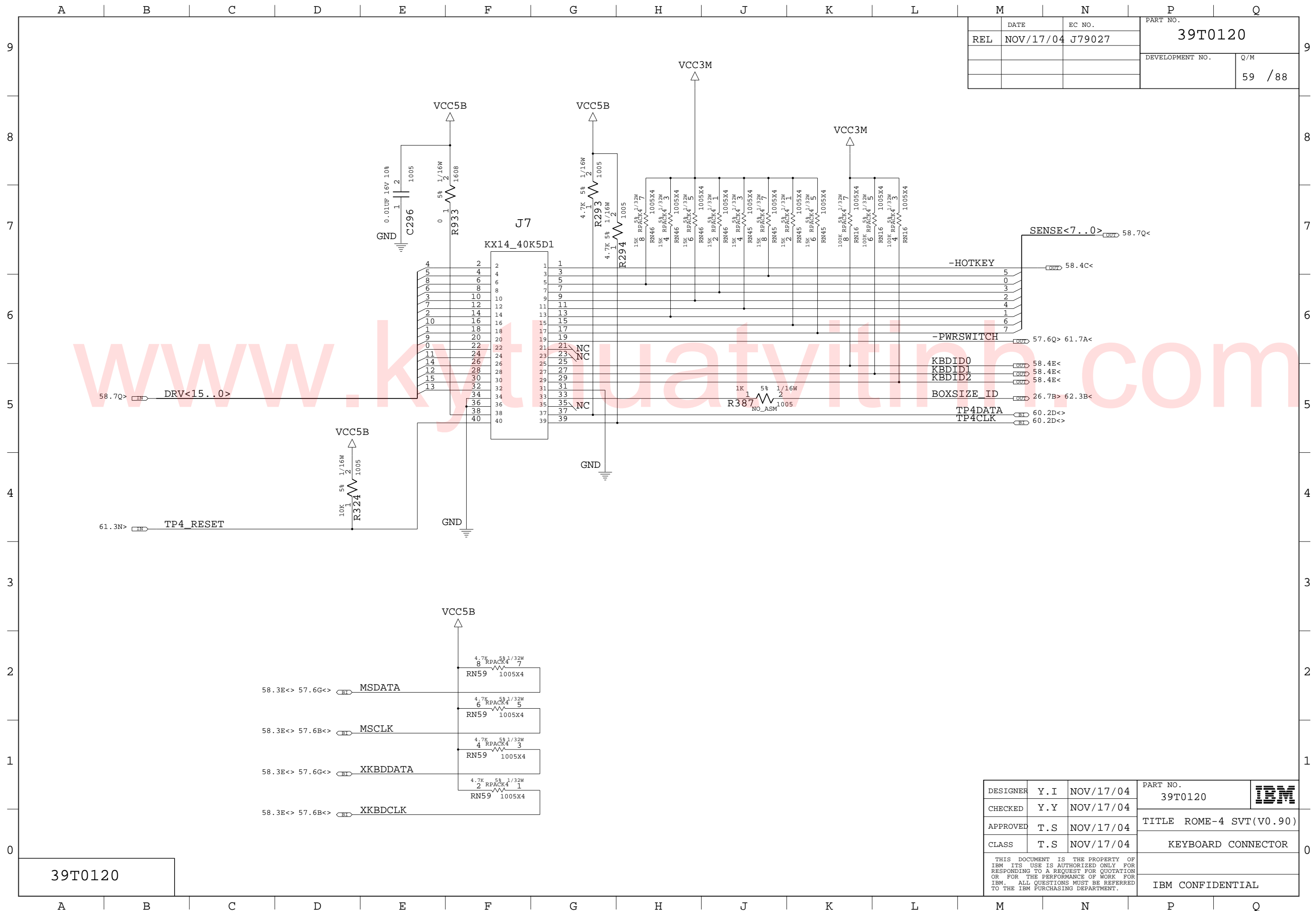

DATE	NOV/17/04	EC NO.	J79027	PART NO.	39T0120
REL				DEVELOPMENT NO.	59 / 88
				Q/M	

39T0120

DESIGNER	Y.I	NOV/17/04	PART NO.	39T0120	IBM
CHECKED	Y.Y	NOV/17/04	TITLE	ROME-4 SVT(V0.90)	
APPROVED	T.S	NOV/17/04	CLASS	KEYBOARD CONNECTOR	
THIS DOCUMENT IS THE PROPERTY OF IBM. ITS USE IS AUTHORIZED ONLY FOR RESPONDING TO A REQUEST FOR QUOTATION OR FOR THE PERFORMANCE OF WORK FOR IBM. ALL QUESTIONS MUST BE REFERRED TO THE IBM PURCHASING DEPARTMENT.					IBM CONFIDENTIAL

	DATE	EC NO.	PART NO.
REL	NOV/17/04	J79027	39T0120
			DEVELOPMENT NO.
			Q/M
			60 / 88

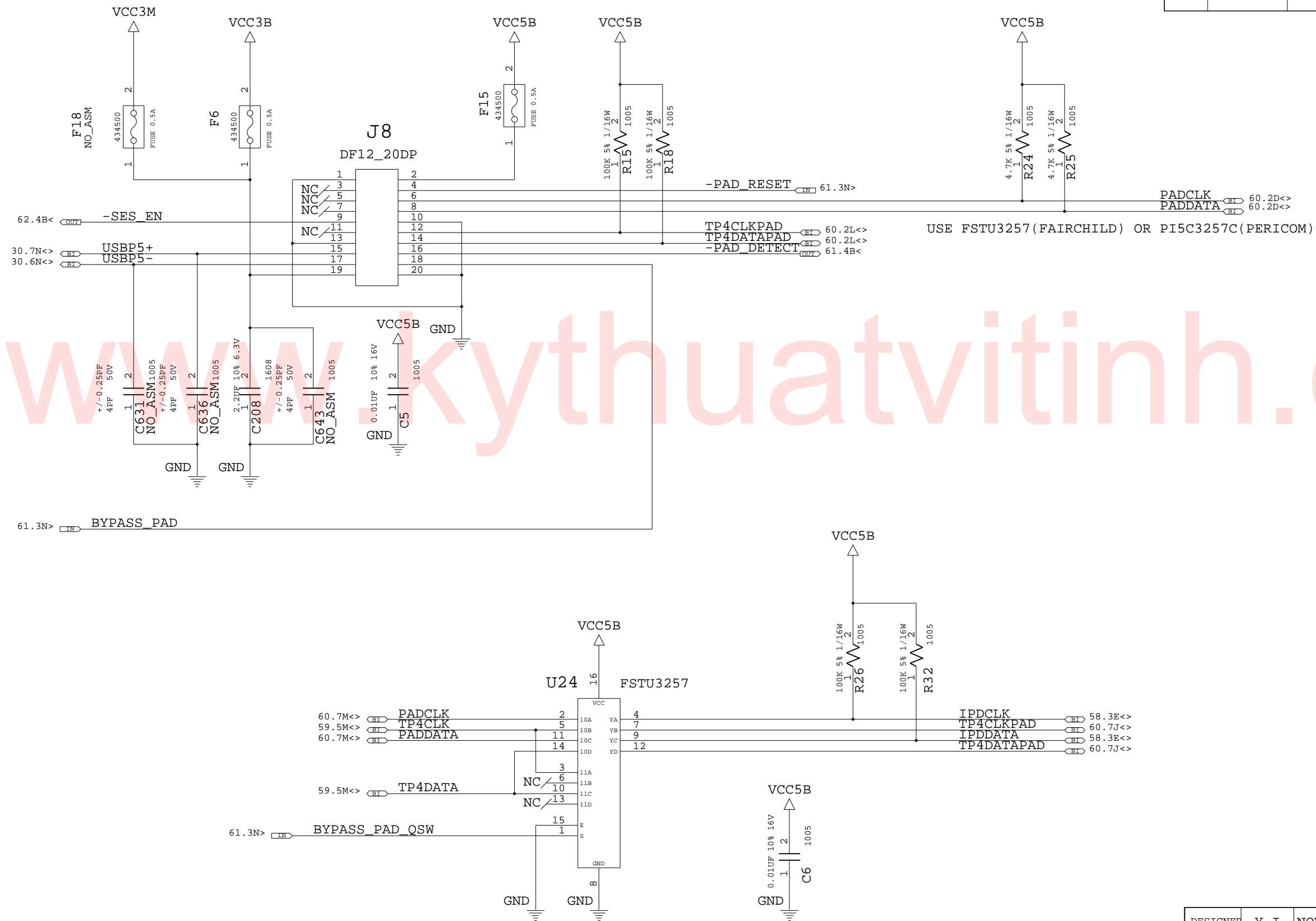

39T0120

DESIGNER	Y.I	NOV/17/04	PART NO.	IBM
CHECKED	Y.Y	NOV/17/04	39T0120	
APPROVED	T.S	NOV/17/04	TITLE	ROME-4 SVT(V0.90)
CLASS	T.S	NOV/17/04	TITLE	TOUCH PAD CONNECTOR
THIS DOCUMENT IS THE PROPERTY OF IBM. ITS USE IS AUTHORIZED ONLY FOR RESPONDING TO A REQUEST FOR QUOTATION OR FOR THE PERFORMANCE OF WORK FOR IBM. ALL QUESTIONS MUST BE REFERRED TO THE IBM PURCHASING DEPARTMENT.				IBM CONFIDENTIAL



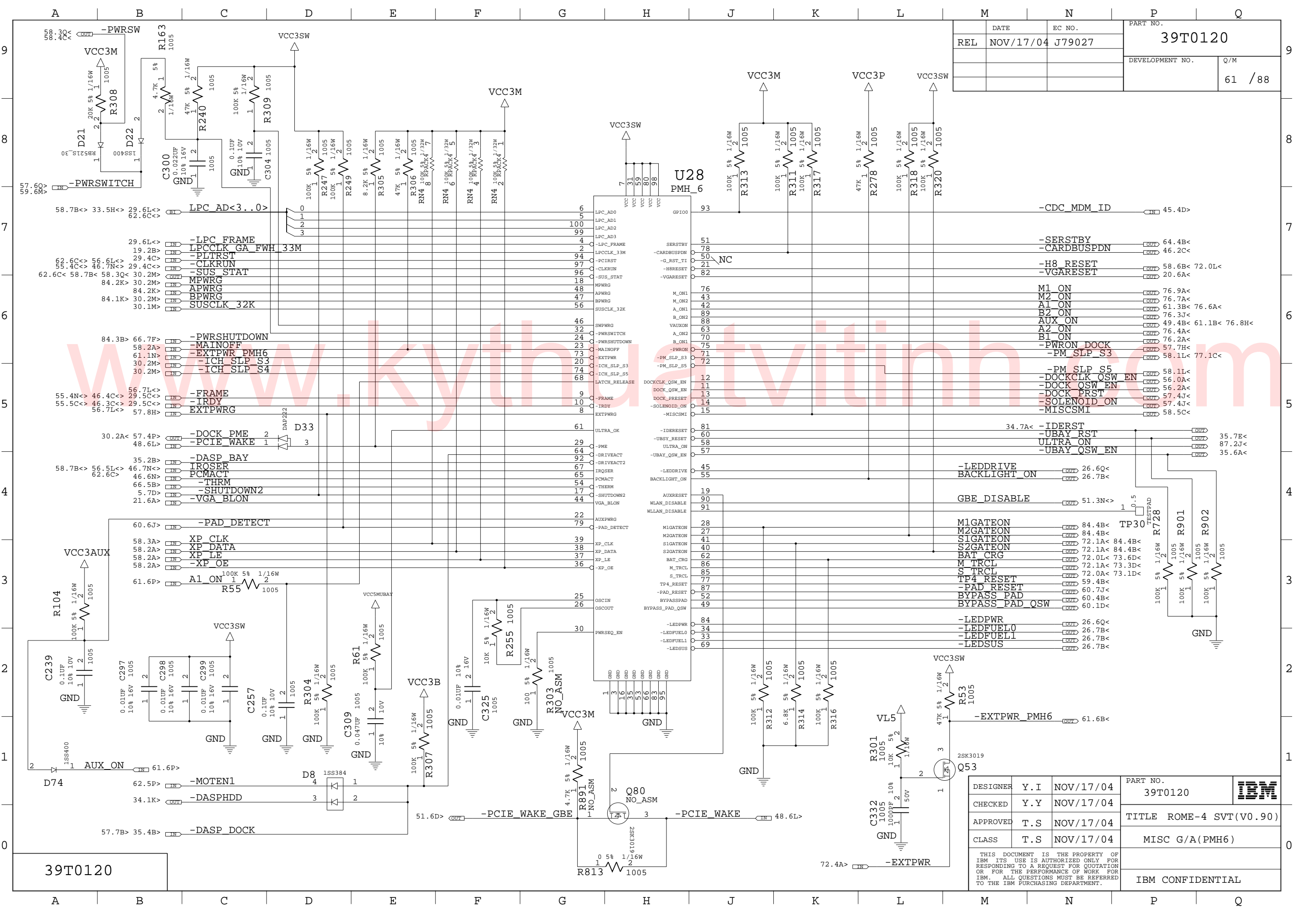

DATE	EC NO.	PART NO.
NOV/17/04	J79027	39T0120
DEVELOPMENT NO.		Q/M
		61 / 88

DESIGNER	Y.I	NOV/17/04	PART NO.	39T0120	
CHECKED	Y.Y	NOV/17/04	TITLE		
APPROVED	T.S	NOV/17/04	MISC G/A (PMH6)		
CLASS	T.S	NOV/17/04	IBM CONFIDENTIAL		

THIS DOCUMENT IS THE PROPERTY OF IBM ITS USE IS AUTHORIZED ONLY FOR RESPONDING TO A REQUEST FOR QUOTATION OR FOR THE PERFORMANCE OF WORK FOR IBM. ALL QUESTIONS MUST BE REFERRED TO THE IBM PURCHASING DEPARTMENT.

39T0120

IBM CONFIDENTIAL

REL	NOV/17/04	J79027	PART NO.	39T0120
			DEVELOPMENT NO.	Q/M
				62 / 88

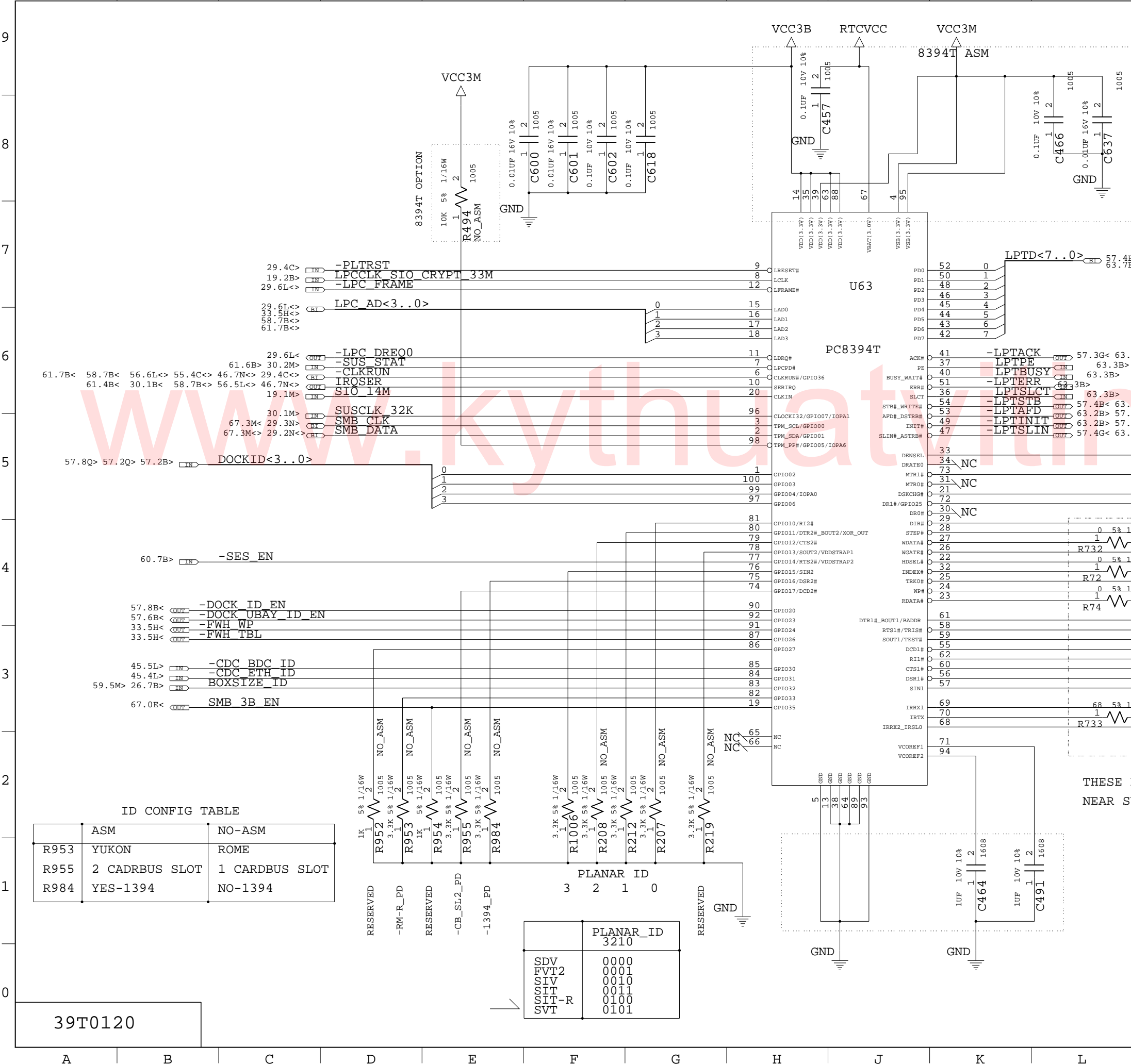

ID CONFIG TABLE

	ASM	NO-ASM
R953	YUKON	ROME
R955	2 CADRBUS SLOT	1 CADRBUS SLOT
R984	YES-1394	NO-1394

PLANAR_ID	
3	SDV
2	FVT2
1	SIV
0	SIT
	SIT-R
	SVT

THESE DUMPPERS SHOULD BE PLACED NEAR SUPER I/O OUTPUT.

BASE ADDRESS 2E-2FH

DESIGNER	Y.I	NOV/17/04	PART NO.	39T0120	IBM
CHECKED	Y.Y	NOV/17/04	TITLE	ROME-4 SVT(V0.90)	
APPROVED	T.S	NOV/17/04	IO KEEPER (SUPER I/O TPM RFID)		
CLASS	T.S	NOV/17/04	100PIN PITCH=0.5MM		
THIS DOCUMENT IS THE PROPERTY OF IBM ITS USE IS AUTHORIZED ONLY FOR RESPONDING TO A REQUEST FOR QUOTATION OR FOR THE PERFORMANCE OF WORK FOR IBM. ALL QUESTIONS MUST BE REFERRED TO THE IBM PURCHASING DEPARTMENT.					IBM CONFIDENTIAL

39T0120



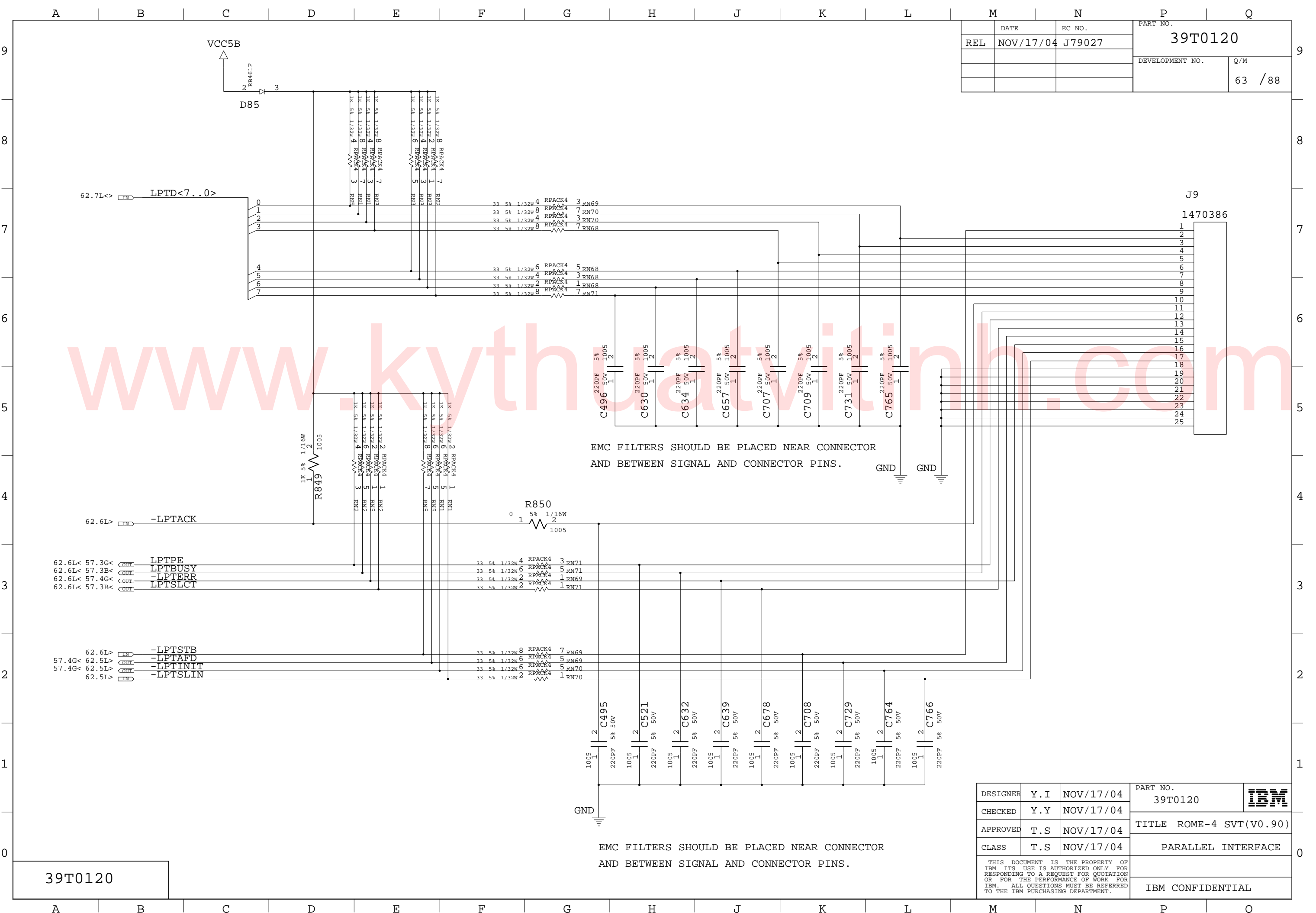

REL	DATE	EC NO.	PART NO.
	NOV/17/04	J79027	39T0120
			DEVELOPMENT NO.
			Q/M
			63 / 88

EMC FILTERS SHOULD BE PLACED NEAR CONNECTOR AND BETWEEN SIGNAL AND CONNECTOR PINS.

EMC FILTERS SHOULD BE PLACED NEAR CONNECTOR AND BETWEEN SIGNAL AND CONNECTOR PINS.

39T0120

DESIGNER	Y.I	NOV/17/04	PART NO.	39T0120	
CHECKED	Y.Y	NOV/17/04			
APPROVED	T.S	NOV/17/04	TITLE ROME-4 SVT(V0.90)		
CLASS	T.S	NOV/17/04	PARALLEL INTERFACE		
THIS DOCUMENT IS THE PROPERTY OF IBM. ITS USE IS AUTHORIZED ONLY FOR RESPONDING TO A REQUEST FOR QUOTATION OR FOR THE PERFORMANCE OF WORK FOR IBM. ALL QUESTIONS MUST BE REFERRED TO THE IBM PURCHASING DEPARTMENT.					IBM CONFIDENTIAL

REL	DATE	EC NO.	PART NO.
	NOV/17/04	J79027	39T0120
			DEVELOPMENT NO.
			Q/M
			64 / 88

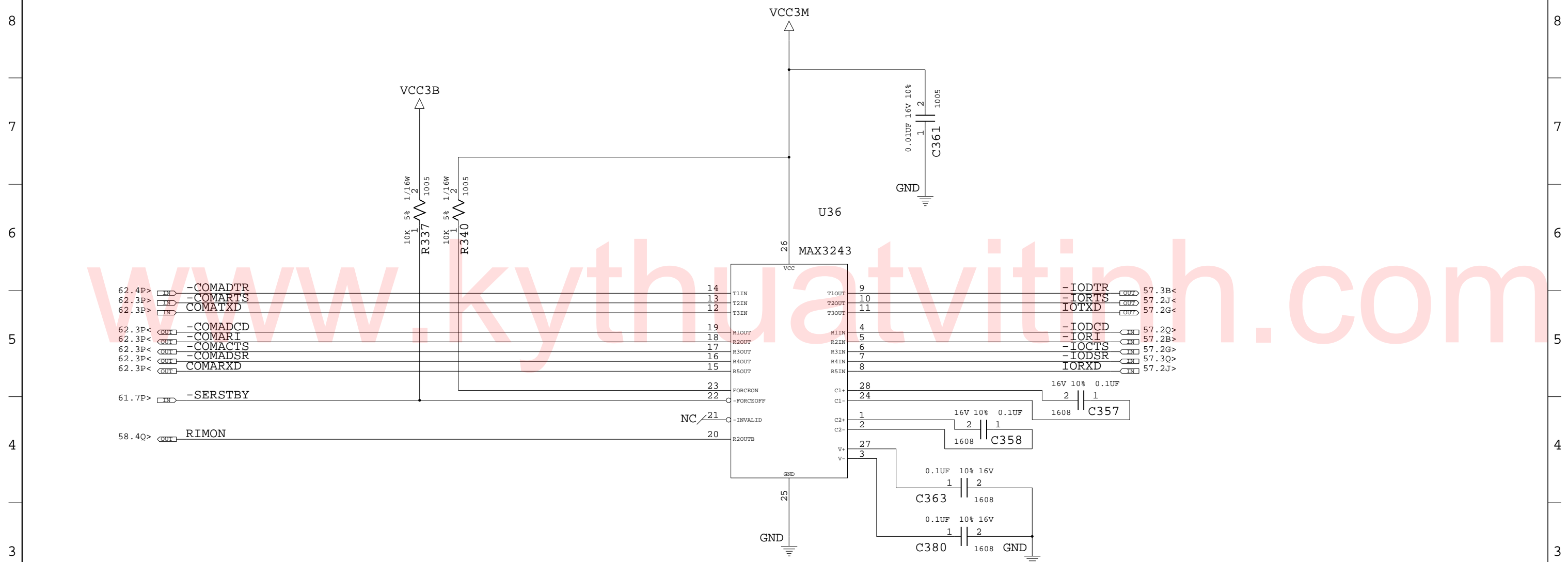

R1IN/R2IN/R3IN/R5IN HAVE INTERNAL PULLDOWN(5K OHM).  
 DO NOT WIRE SIGNALS UNDER PINS (1/2/3/24/25/26/27/28)  
 CHARGE PUMP CAPACITOR SHOULD BE PLACED NEAR PINS(1/2/3/24/27/28)  
 ADD GND SHILED UNDER CHARGE PUMP CIRCUIT TO  
 PROTECT POWER LINE NOISE  
 CAPACITORS FOR CHARGE PUMP SHOULD BE USED TYPE B AND LOW ESR TYPE.

	NORMAL MODE	POWER DOWN MODE	AUTO POWER DOWN MODE
FORCEON	HIGH	DO NOT CARE	LOW
FOCEOFF	HIGH	LOW	HIGH

39T0120

DESIGNER	Y.I	NOV/17/04	PART NO.	39T0120	IBM
CHECKED	Y.Y	NOV/17/04			
APPROVED	T.S	NOV/17/04	TITLE ROME-4 SVT(V0.90)		
CLASS	T.S	NOV/17/04	SERIAL INTERFACE		
THIS DOCUMENT IS THE PROPERTY OF IBM ITS USE IS AUTHORIZED ONLY FOR RESPONDING TO A REQUEST FOR QUOTATION OR FOR THE PERFORMANCE OF WORK FOR IBM. ALL QUESTIONS MUST BE REFERRED TO THE IBM PURCHASING DEPARTMENT.					IBM CONFIDENTIAL

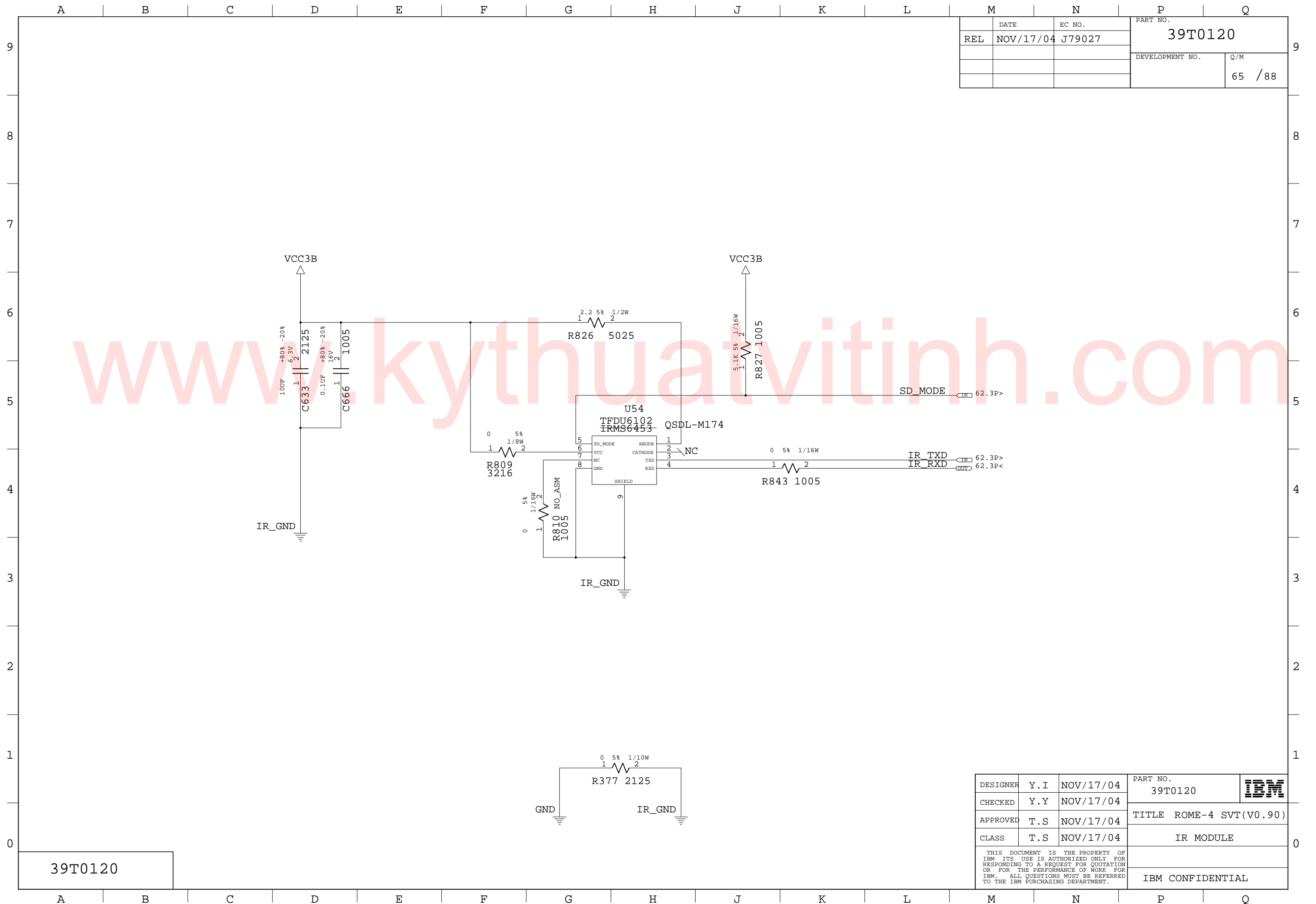

	DATE	EC NO.	PART NO.	
REL	NOV/17/04	J79027	39T0120	
			DEVELOPMENT NO.	Q/M
				65 / 88

39T0120

DESIGNER	Y. I	NOV/17/04	PART NO.	39T0120	<b>IBM</b>
CHECKED	Y. Y	NOV/17/04			
APPROVED	T. S	NOV/17/04	TITLE ROME-4 SVT(V0.90)		
CLASS	T. S	NOV/17/04	IR MODULE		
THIS DOCUMENT IS THE PROPERTY OF IBM. ITS USE IS AUTHORIZED ONLY FOR RESPONDING TO A REQUEST FOR QUOTATION OR FOR THE PERFORMANCE OF WORK FOR IBM. ALL QUESTIONS MUST BE REFERRED TO THE IBM PURCHASING DEPARTMENT.				IBM CONFIDENTIAL	

DATE	EC NO.	PART NO.
REL NOV/17/04	J79027	39T0120
DEVELOPMENT NO.		Q/M
		66 / 88

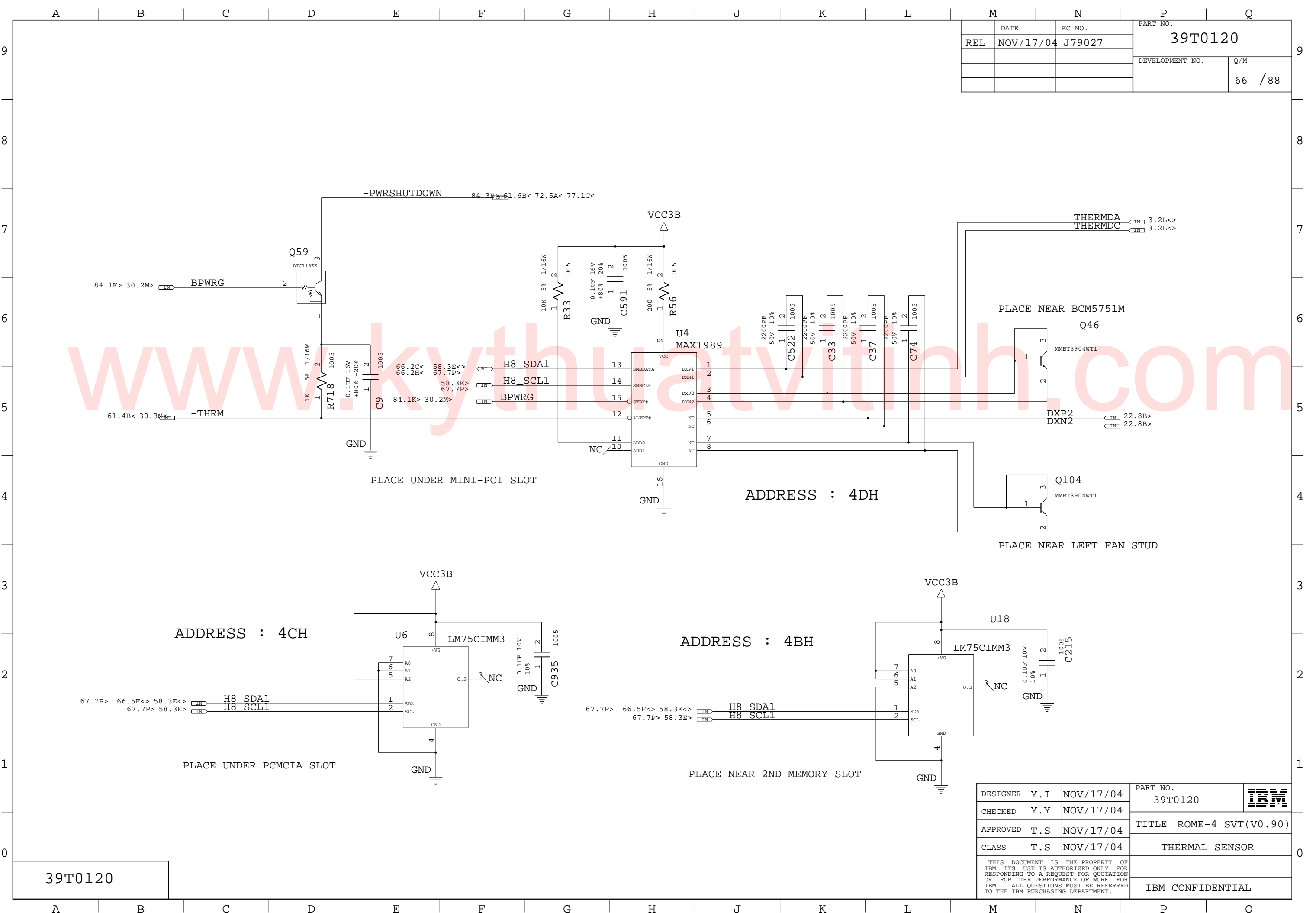

39T0120

DESIGNER	Y.I	NOV/17/04	PART NO.	39T0120	<b>IBM</b>
CHECKED	Y.Y	NOV/17/04			
APPROVED	T.S	NOV/17/04	TITLE ROME-4 SVT(V0.90)		
CLASS	T.S	NOV/17/04	THERMAL SENSOR		
THIS DOCUMENT IS THE PROPERTY OF IBM. ITS USE IS AUTHORIZED ONLY FOR RESPONDING TO A REQUEST FOR QUOTATION OR FOR THE PERFORMANCE OF WORK FOR IBM. ALL QUESTIONS MUST BE REFERRED TO THE IBM PURCHASING DEPARTMENT.				IBM CONFIDENTIAL	

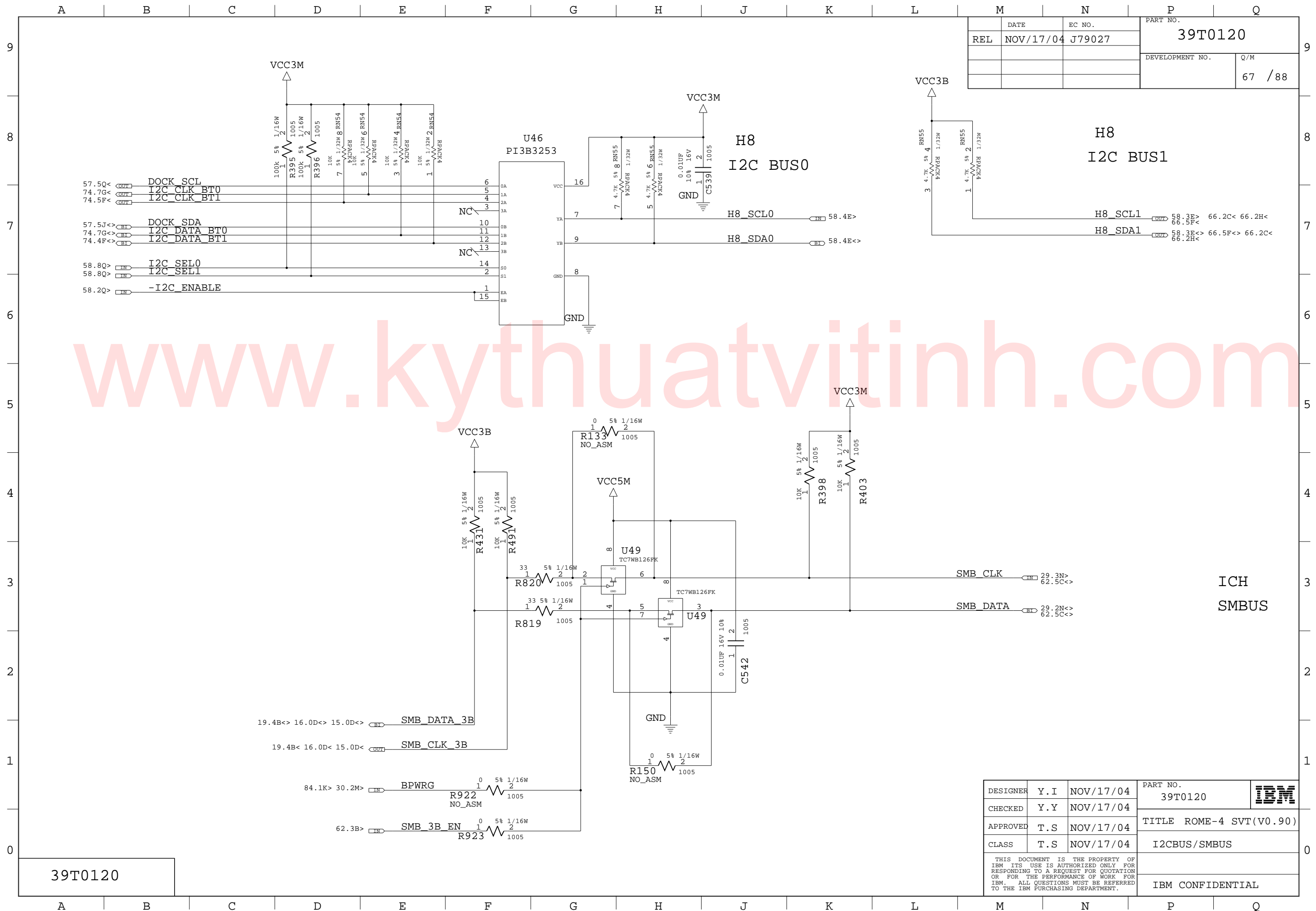

	DATE	EC NO.	PART NO.	
REL	NOV/17/04	J79027	39T0120	
			DEVELOPMENT NO.	Q/M
				67 / 88

www.kythuatvithinh.com

39T0120

DESIGNER	Y.I	NOV/17/04	PART NO.	39T0120	
CHECKED	Y.Y	NOV/17/04			
APPROVED	T.S	NOV/17/04	TITLE ROME-4 SVT(V0.90)		
CLASS	T.S	NOV/17/04	I2CBUS/SMBUS		
THIS DOCUMENT IS THE PROPERTY OF IBM ITS USE IS AUTHORIZED ONLY FOR RESPONDING TO A REQUEST FOR QUOTATION OR FOR THE PERFORMANCE OF WORK FOR IBM. ALL QUESTIONS MUST BE REFERRED TO THE IBM PURCHASING DEPARTMENT.				IBM CONFIDENTIAL	

	DATE	EC NO.	PART NO.	
REL	NOV/17/04	J79027	39T0120	
			DEVELOPMENT NO.	Q/M
				68 / 88

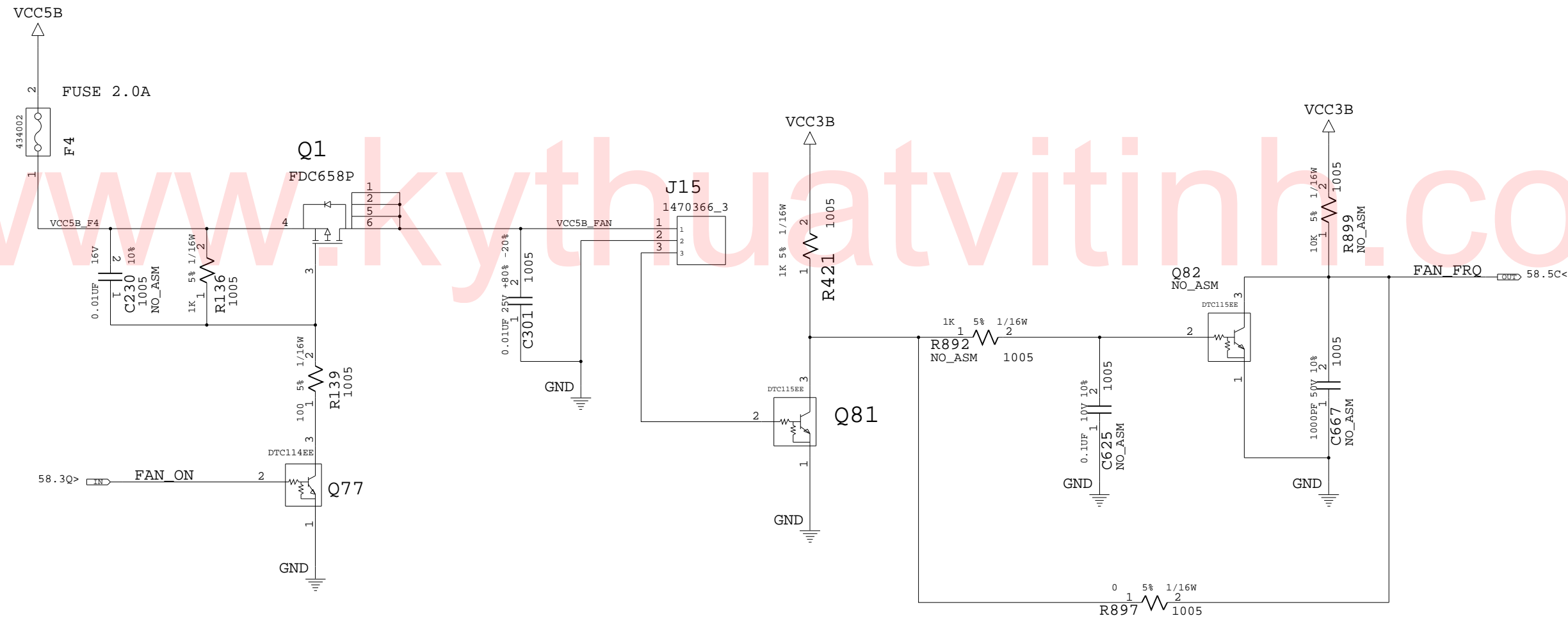

39T0120

DESIGNER	Y. I	NOV/17/04	PART NO.	39T0120	IBM
CHECKED	Y. Y	NOV/17/04			
APPROVED	T. S	NOV/17/04	TITLE ROME-4 SVT(V0.90)		
CLASS	T. S	NOV/17/04	FAN CONNECTOR		
THIS DOCUMENT IS THE PROPERTY OF IBM ITS USE IS AUTHORIZED ONLY FOR RESPONDING TO A REQUEST FOR QUOTATION OR FOR THE PERFORMANCE OF WORK FOR IBM. ALL QUESTIONS MUST BE REFERRED TO THE IBM PURCHASING DEPARTMENT.				IBM CONFIDENTIAL	



DATE	NOV/17/04	EC NO.	J79027	PART NO.	39T0120
REL	1			DEVELOPMENT NO.	Q/M
					69 / 88

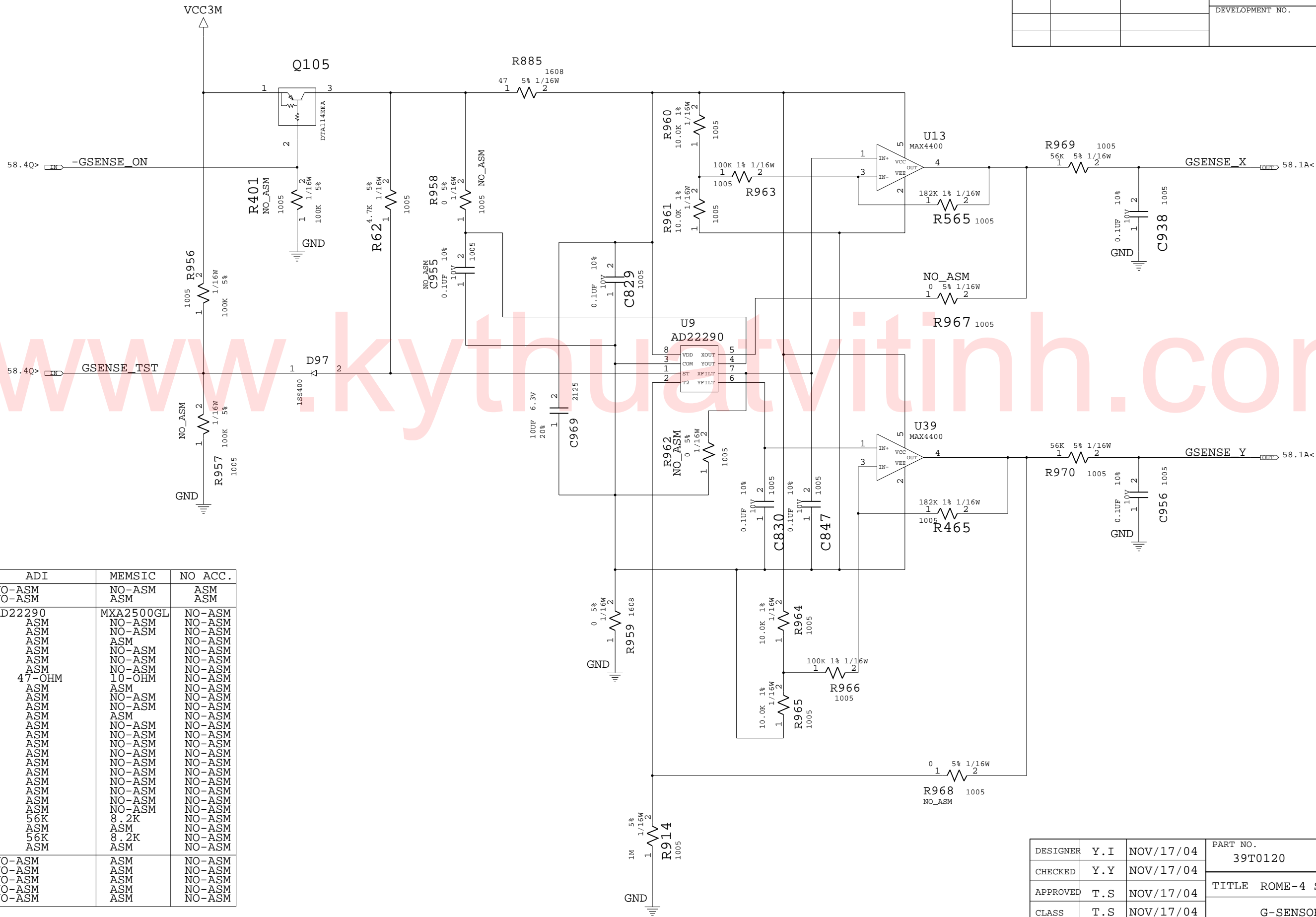

	ADI	MEMSIC	NO ACC.
R401	NO-ASM	NO-ASM	ASM
R957	NO-ASM	ASM	ASM
U9	AD22290	MXA2500GL	NO-ASM
U13	ASM	NO-ASM	NO-ASM
U39	ASM	NO-ASM	NO-ASM
Q105	ASM	ASM	NO-ASM
D97	ASM	NO-ASM	NO-ASM
R956	ASM	NO-ASM	NO-ASM
R958	ASM	NO-ASM	NO-ASM
R885	47-OHM	10-OHM	NO-ASM
C829	ASM	ASM	NO-ASM
R961	ASM	NO-ASM	NO-ASM
R963	ASM	NO-ASM	NO-ASM
R965	ASM	NO-ASM	NO-ASM
R966	ASM	NO-ASM	NO-ASM
R967	ASM	NO-ASM	NO-ASM
R968	ASM	NO-ASM	NO-ASM
R969	ASM	NO-ASM	NO-ASM
R970	ASM	NO-ASM	NO-ASM
R914	ASM	NO-ASM	NO-ASM
C955	NO-ASM	ASM	NO-ASM
C938	NO-ASM	ASM	NO-ASM
C830	NO-ASM	ASM	NO-ASM
C847	NO-ASM	ASM	NO-ASM
C956	NO-ASM	ASM	NO-ASM
C938	NO-ASM	ASM	NO-ASM
R956	NO-ASM	ASM	NO-ASM
R958	NO-ASM	ASM	NO-ASM
R885	NO-ASM	ASM	NO-ASM
R961	NO-ASM	ASM	NO-ASM
R963	NO-ASM	ASM	NO-ASM
R965	NO-ASM	ASM	NO-ASM
R966	NO-ASM	ASM	NO-ASM
R967	NO-ASM	ASM	NO-ASM
R968	NO-ASM	ASM	NO-ASM
R969	NO-ASM	ASM	NO-ASM
R970	NO-ASM	ASM	NO-ASM
R914	NO-ASM	ASM	NO-ASM

39T0120

DESIGNER	Y.I	NOV/17/04	PART NO.	39T0120	IBM
CHECKED	Y.Y	NOV/17/04	TITLE	ROME-4 SVT(V0.90)	
APPROVED	T.S	NOV/17/04	CLASS	G-SENSOR	
THIS DOCUMENT IS THE PROPERTY OF IBM. ITS USE IS AUTHORIZED ONLY FOR RESPONDING TO A REQUEST FOR QUOTATION OR FOR THE PERFORMANCE OF WORK FOR IBM. ALL QUESTIONS MUST BE REFERRED TO THE IBM PURCHASING DEPARTMENT.					IBM CONFIDENTIAL

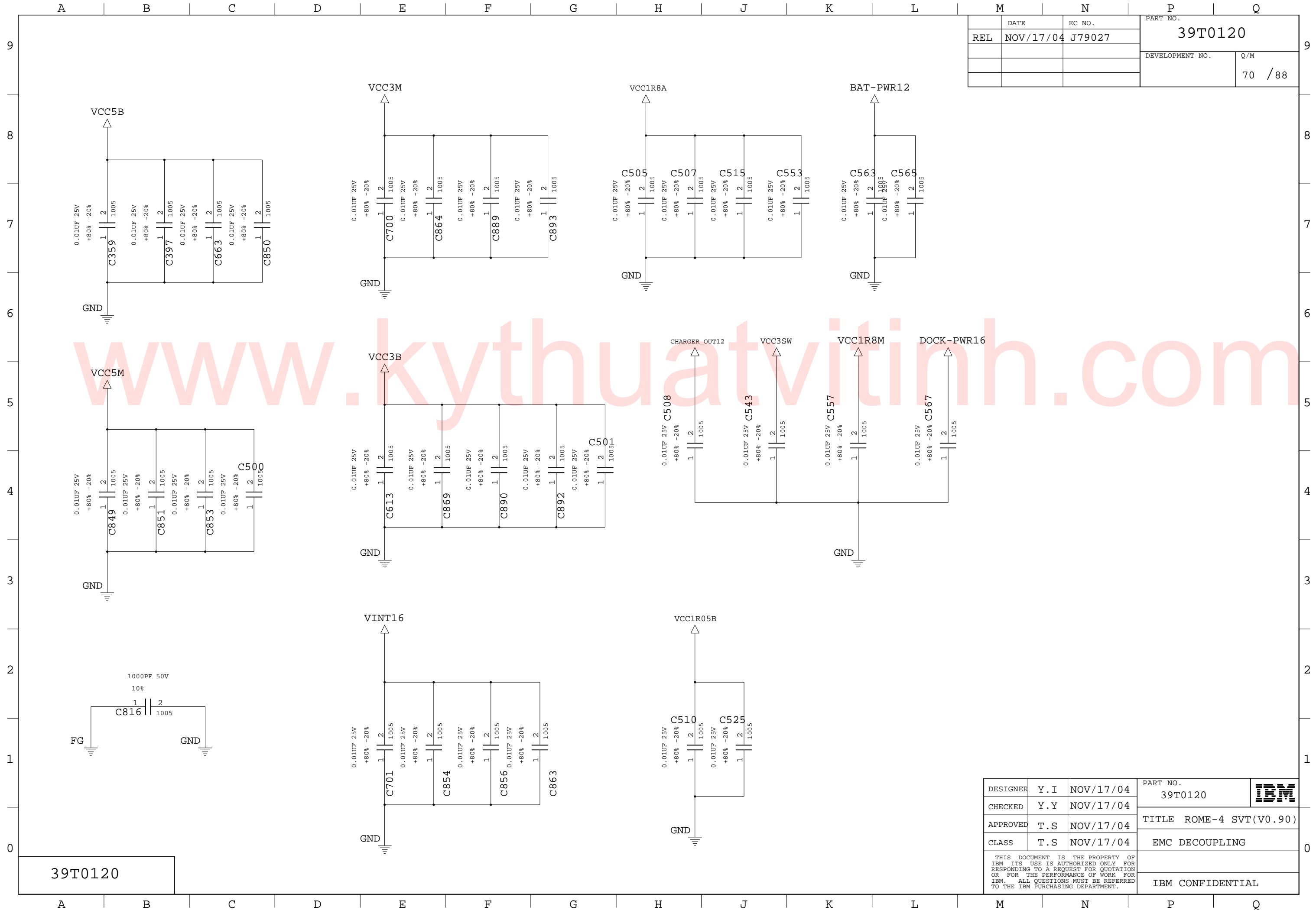

	DATE	EC NO.	PART NO.
REL	NOV/17/04	J79027	39T0120
			DEVELOPMENT NO.
			Q/M
			70 / 88

39T0120

DESIGNER	Y.I	NOV/17/04	PART NO.	39T0120	IBM
CHECKED	Y.Y	NOV/17/04			
APPROVED	T.S	NOV/17/04	TITLE ROME-4 SVT(V0.90)		
CLASS	T.S	NOV/17/04	EMC DECOUPLING		
THIS DOCUMENT IS THE PROPERTY OF IBM ITS USE IS AUTHORIZED ONLY FOR RESPONDING TO A REQUEST FOR QUOTATION OR FOR THE PERFORMANCE OF WORK FOR IBM. ALL QUESTIONS MUST BE REFERRED TO THE IBM PURCHASING DEPARTMENT.				IBM CONFIDENTIAL	

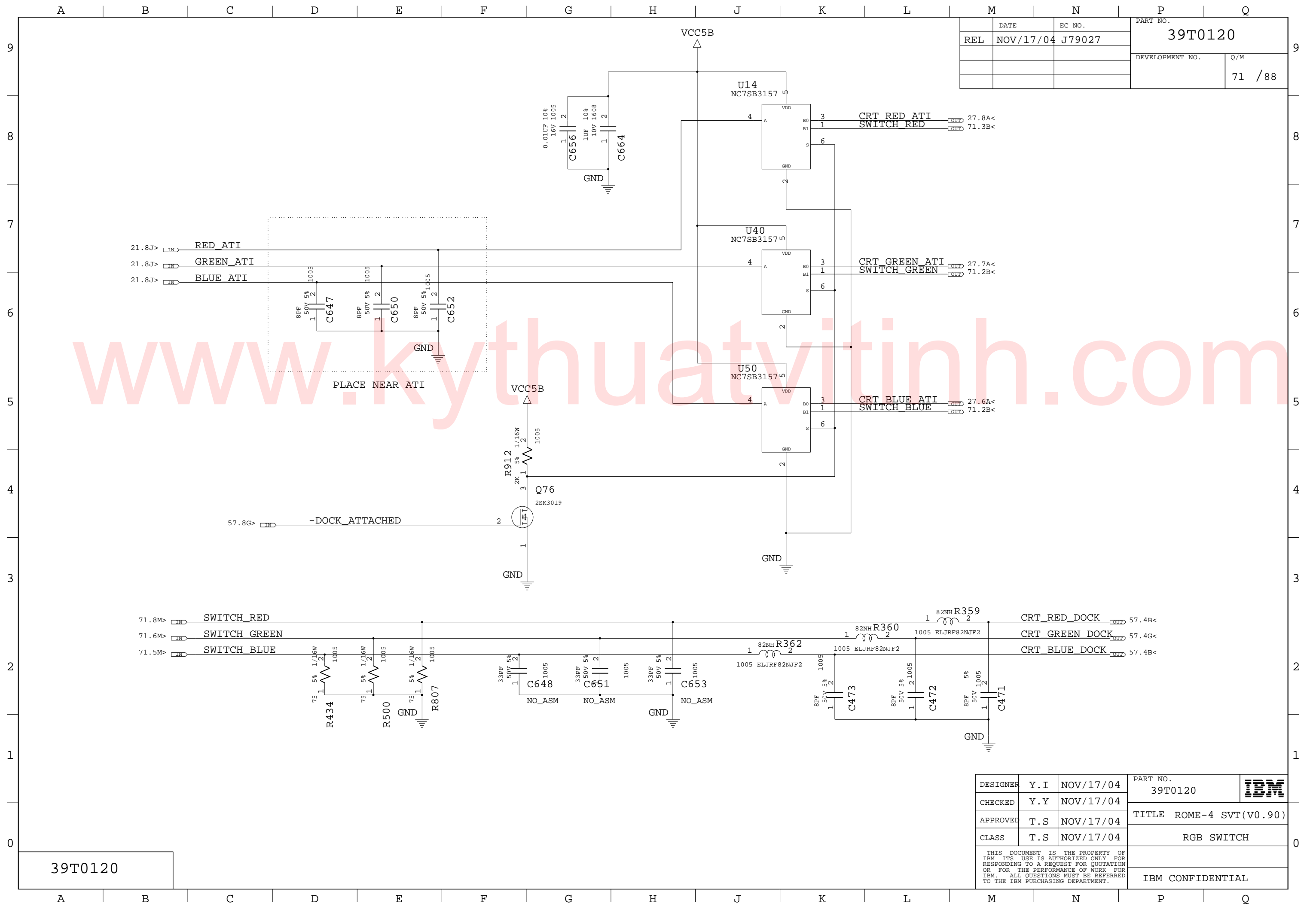

REL	DATE	EC NO.	PART NO.
	NOV/17/04	J79027	39T0120
			DEVELOPMENT NO.
			Q/M
			71 / 88

39T0120

DESIGNER	Y. I	NOV/17/04	PART NO.	39T0120	IBM
CHECKED	Y. Y	NOV/17/04			
APPROVED	T. S	NOV/17/04	TITLE ROME-4 SVT(V0.90)		
CLASS	T. S	NOV/17/04	RGB SWITCH		
THIS DOCUMENT IS THE PROPERTY OF IBM ITS USE IS AUTHORIZED ONLY FOR RESPONDING TO A REQUEST FOR QUOTATION OR FOR THE PERFORMANCE OF WORK FOR IBM. ALL QUESTIONS MUST BE REFERRED TO THE IBM PURCHASING DEPARTMENT.					IBM CONFIDENTIAL

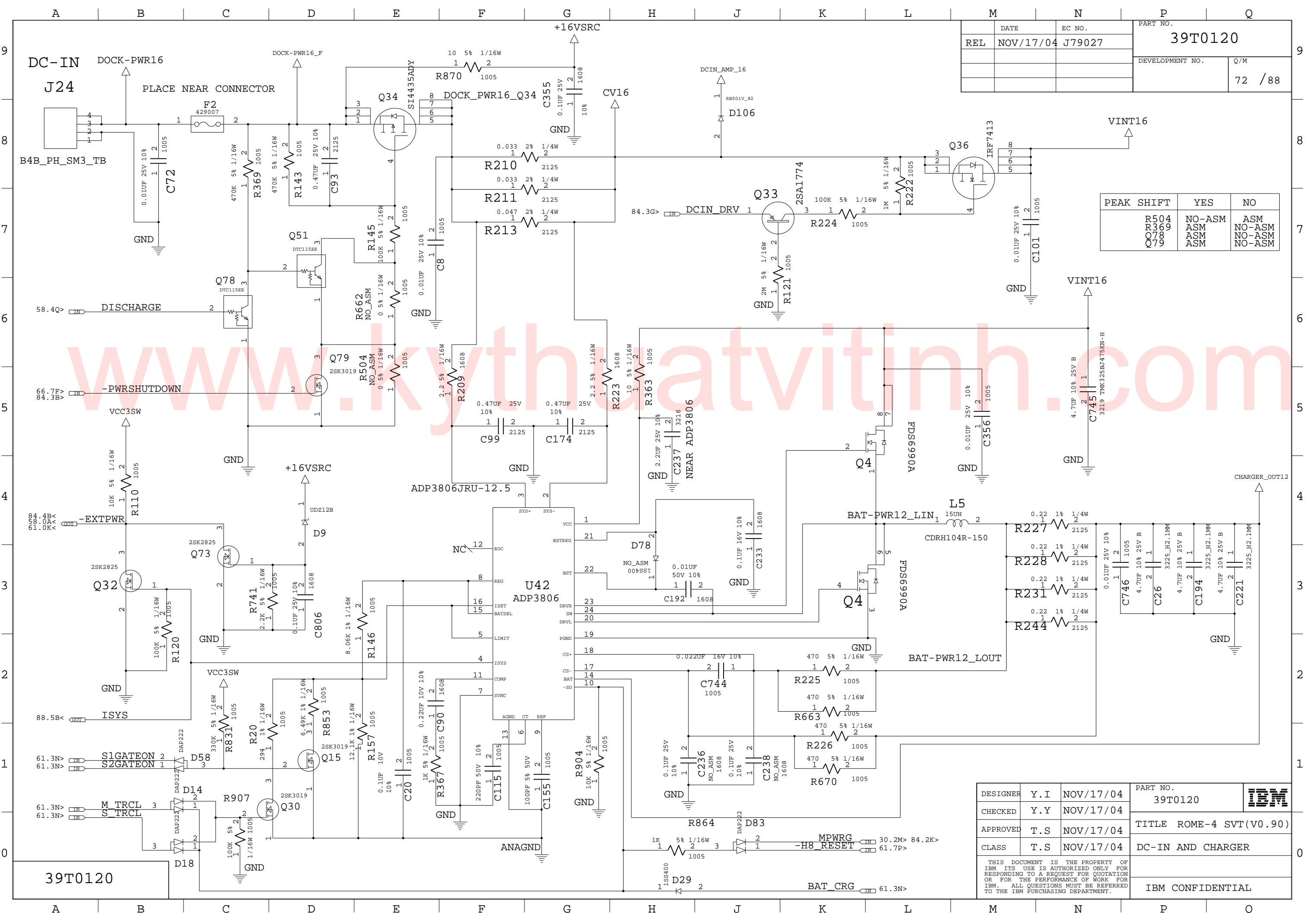

REL	NOV/17/04	J79027	PART NO.	39T0120
			DEVELOPMENT NO.	Q/M
				72 / 88

PEAK SHIFT	YES	NO
R504	NO-ASM	ASM
R3069	ASM	NO-ASM
Q789	ASM	NO-ASM
Q79	ASM	NO-ASM

DESIGNER	Y.I	NOV/17/04	PART NO.	39T0120	
CHECKED	Y.Y	NOV/17/04			
APPROVED	T.S	NOV/17/04	TITLE		ROME-4 SVT(V0.90)
CLASS	T.S	NOV/17/04	DC-IN AND CHARGER		
THIS DOCUMENT IS THE PROPERTY OF IBM ITS USE IS AUTHORIZED ONLY FOR RESPONDING TO A REQUEST FOR QUOTATION OR FOR THE PERFORMANCE OF WORK FOR IBM. ALL QUESTIONS MUST BE REFERRED TO THE IBM PURCHASING DEPARTMENT.					IBM CONFIDENTIAL

39T0120

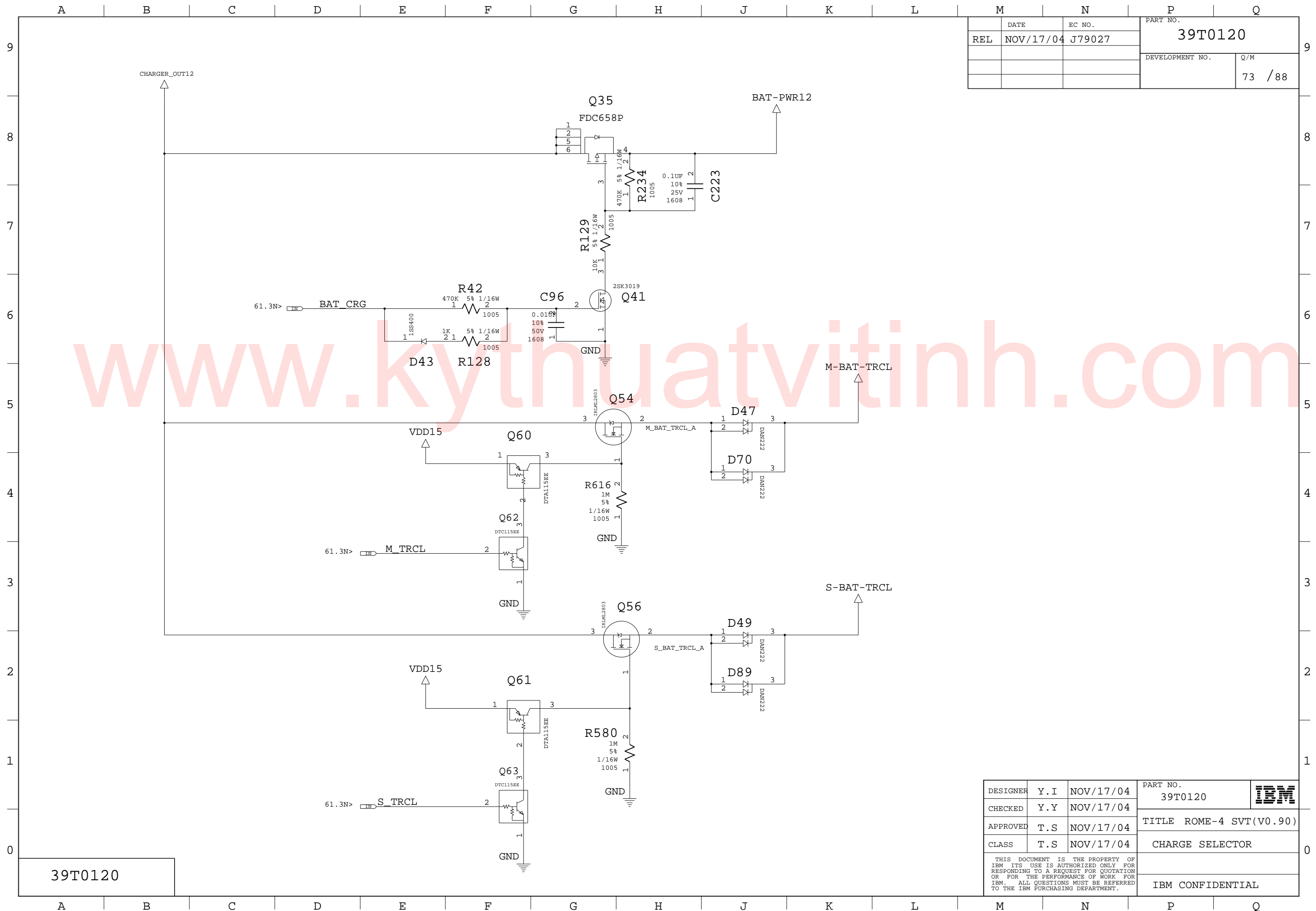

REL	DATE	EC NO.	PART NO.
	NOV/17/04	J79027	39T0120
			DEVELOPMENT NO.
			Q/M
			73 / 88

39T0120

DESIGNER	Y.I	NOV/17/04	PART NO.	39T0120	IBM
CHECKED	Y.Y	NOV/17/04			
APPROVED	T.S	NOV/17/04	TITLE ROME-4 SVT(V0.90)		
CLASS	T.S	NOV/17/04	CHARGE SELECTOR		
THIS DOCUMENT IS THE PROPERTY OF IBM. ITS USE IS AUTHORIZED ONLY FOR RESPONDING TO A REQUEST FOR QUOTATION OR FOR THE PERFORMANCE OF WORK FOR IBM. ALL QUESTIONS MUST BE REFERRED TO THE IBM PURCHASING DEPARTMENT.					IBM CONFIDENTIAL

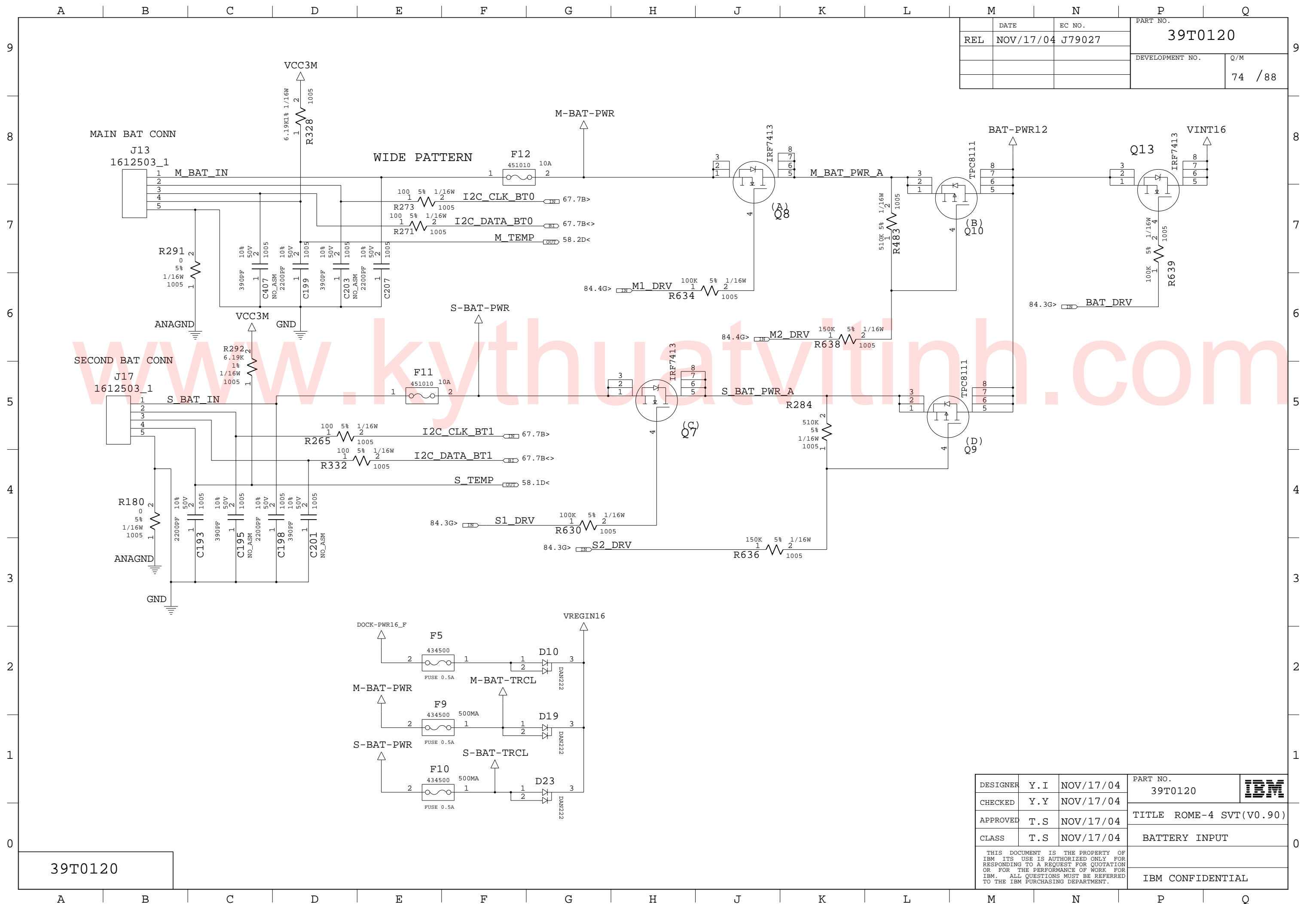

DATE	NOV/17/04	EC NO.	J79027	PART NO.	39T0120
REL				DEVELOPMENT NO.	Q/M
					74 / 88

39T0120

DESIGNER	Y.I	NOV/17/04	PART NO.	39T0120	IBM
CHECKED	Y.Y	NOV/17/04	TITLE	ROME-4 SVT(V0.90)	
APPROVED	T.S	NOV/17/04	CLASS	BATTERY INPUT	
THIS DOCUMENT IS THE PROPERTY OF IBM ITS USE IS AUTHORIZED ONLY FOR RESPONDING TO A REQUEST FOR QUOTATION OR FOR THE PERFORMANCE OF WORK FOR IBM. ALL QUESTIONS MUST BE REFERRED TO THE IBM PURCHASING DEPARTMENT.					IBM CONFIDENTIAL



	DATE	EC NO.	PART NO.	
REL	NOV/17/04	J79027	39T0120	
			DEVELOPMENT NO.	Q/M
				75 / 88

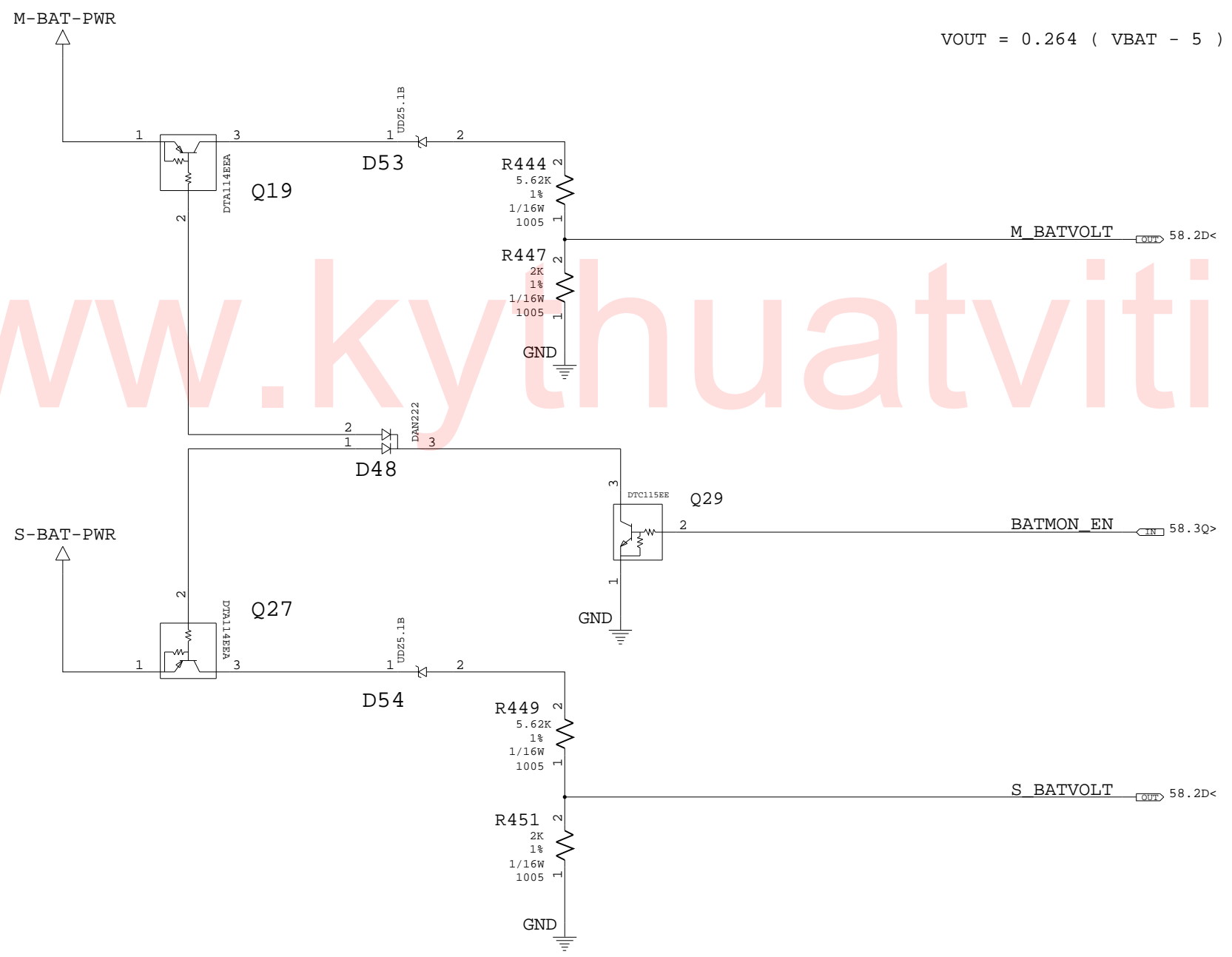

39T0120

DESIGNER	Y. I	NOV/17/04	PART NO.	IBM
CHECKED	Y. Y	NOV/17/04	39T0120	
APPROVED	T. S	NOV/17/04	TITLE ROME-4 SVT(V0.90)	
CLASS	T. S	NOV/17/04	BATTERY MONITOR	
THIS DOCUMENT IS THE PROPERTY OF IBM. ITS USE IS AUTHORIZED ONLY FOR RESPONDING TO A REQUEST FOR QUOTATION OR FOR THE PERFORMANCE OF WORK FOR IBM. ALL QUESTIONS MUST BE REFERRED TO THE IBM PURCHASING DEPARTMENT.				IBM CONFIDENTIAL

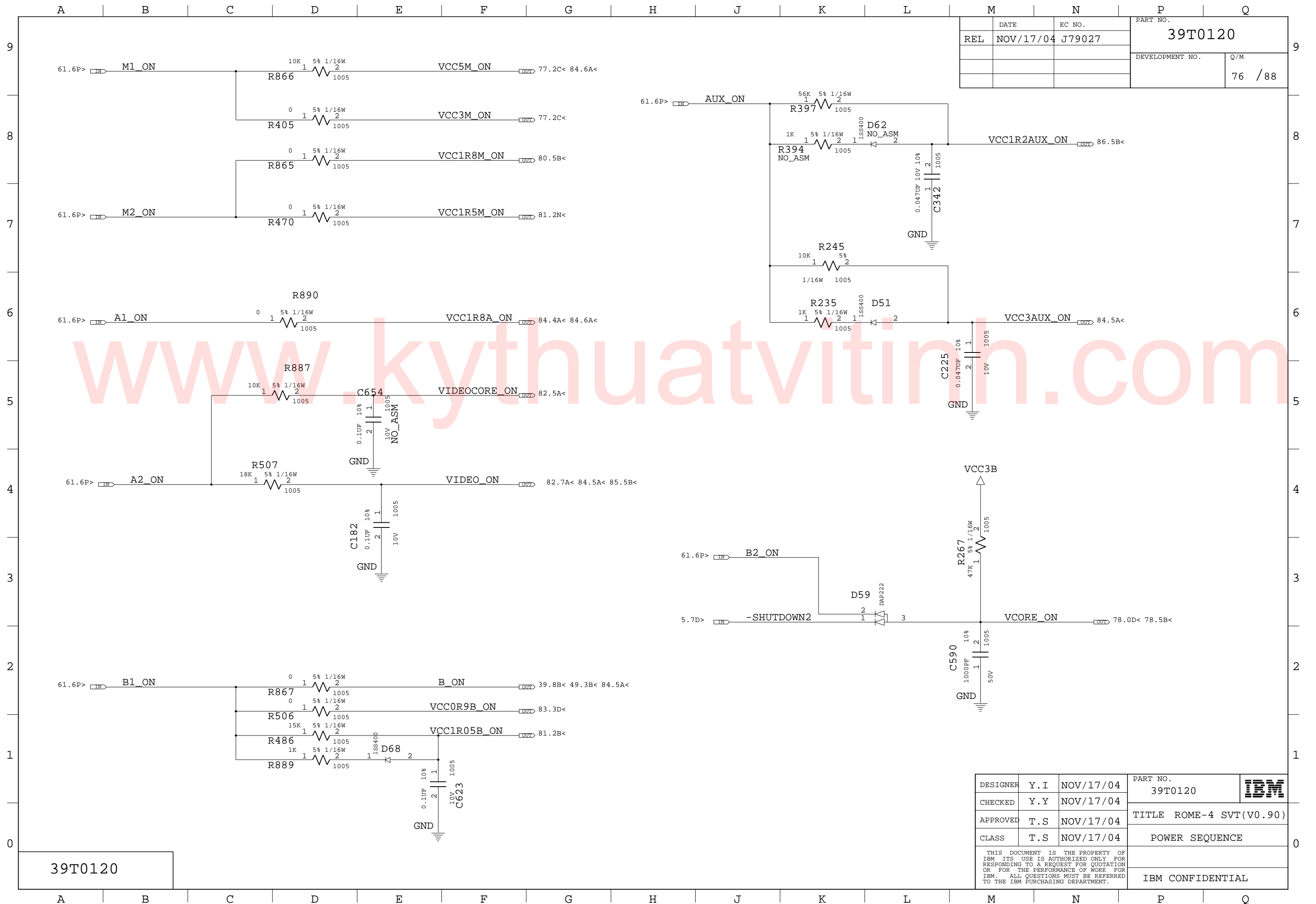

DATE	NOV/17/04	EC NO.	J79027	PART NO.	39T0120
REL				DEVELOPMENT NO.	76 / 88

39T0120

DESIGNER	Y.I	NOV/17/04	PART NO.	39T0120	IBM
CHECKED	Y.Y	NOV/17/04	TITLE	ROME-4 SVT(V0.90)	
APPROVED	T.S	NOV/17/04	CLASS	POWER SEQUENCE	
THIS DOCUMENT IS THE PROPERTY OF IBM. ITS USE IS AUTHORIZED ONLY FOR RESPONDING TO A REQUEST FOR QUOTATION OR FOR THE PERFORMANCE OF WORK FOR IBM. ALL QUESTIONS MUST BE REFERRED TO THE IBM PURCHASING DEPARTMENT.					IBM CONFIDENTIAL

A B C D E F G H J K L M N P Q

VCC3M TABLE 1/1

VCC3M	4.0A	5.0A
R987	NO-ASM	ASM
L4	CDRH104R_10UH_4R4A	CDRH104R_5R2UH_5R5A
Q100	NO-ASM	ASM
C217	NO-ASM	ASM

REL	DATE	EC NO.	PART NO.
	NOV/17/04	J79027	39T0120
			DEVELOPMENT NO.
			Q/M
			77 / 88

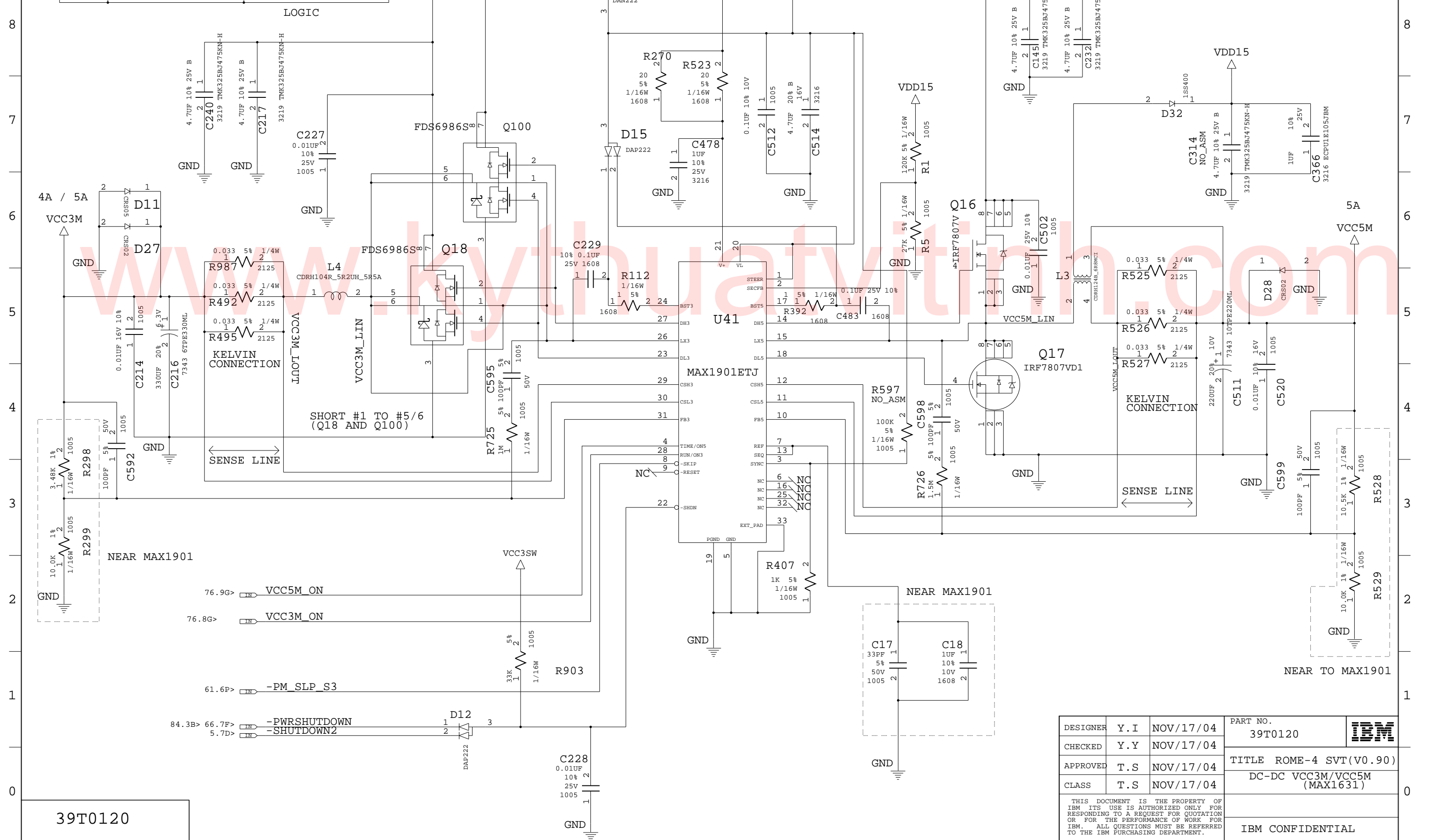

39T0120

DESIGNER	Y.I	NOV/17/04	PART NO.	39T0120	
CHECKED	Y.Y	NOV/17/04	TITLE ROME-4 SVT(V0.90)		
APPROVED	T.S	NOV/17/04	DC-DC VCC3M/VCC5M (MAX1631)		
CLASS	T.S	NOV/17/04	IBM CONFIDENTIAL		

A B C D E F G H J K L M N P Q

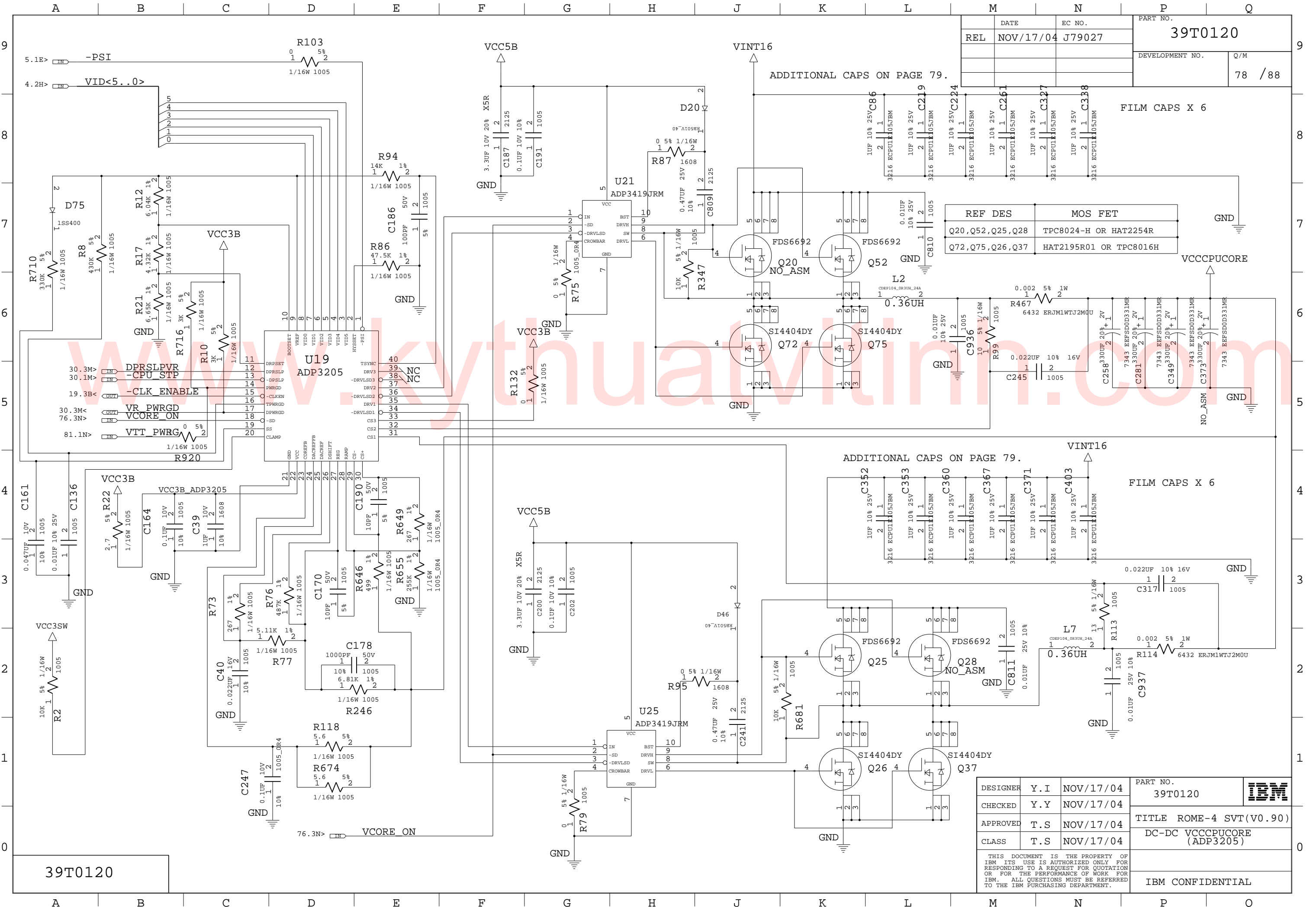

REL	NOV/17/04	J79027	DATE	EC NO.	J79027	PART NO.	39T0120
DEVELOPMENT NO.						Q/M	78 / 88

REF DES	MOS FET	
Q20, Q52, Q25, Q28	TPC8024-H OR HAT2254R	
Q72, Q75, Q26, Q37	HAT2195R01 OR TPC8016H	

C258	330UF 20% 2V	
C281	330UF 20% 2V	
C349	330UF 20% 2V	
C373	330UF 20% 2V	
C734	EFESD0331MR	
C734	EFESD0331MR	
C734	EFESD0331MR	
C734	EFESD0331MR	
C734	EFESD0331MR	

DESIGNER	Y.I	NOV/17/04	PART NO.	39T0120	
CHECKED	Y.Y	NOV/17/04	TITLE	ROME-4 SVT(V0.90)	
APPROVED	T.S	NOV/17/04	DC-DC VCCCPUCORE	(ADP3205)	
CLASS	T.S	NOV/17/04	IBMPURCHASING DEPARTMENT.	IBMPURCHASING DEPARTMENT.	

39T0120

	DATE	EC NO.	PART NO.	
REL	NOV/17/04	J79027	39T0120	
			DEVELOPMENT NO.	Q/M
				79 /88

9  
8  
7  
6  
5  
4  
3  
2  
1  
0

FOLLOWING 23 PCS OF 1.5UF ARE NO-ASM FOR VCCCPUCORE.

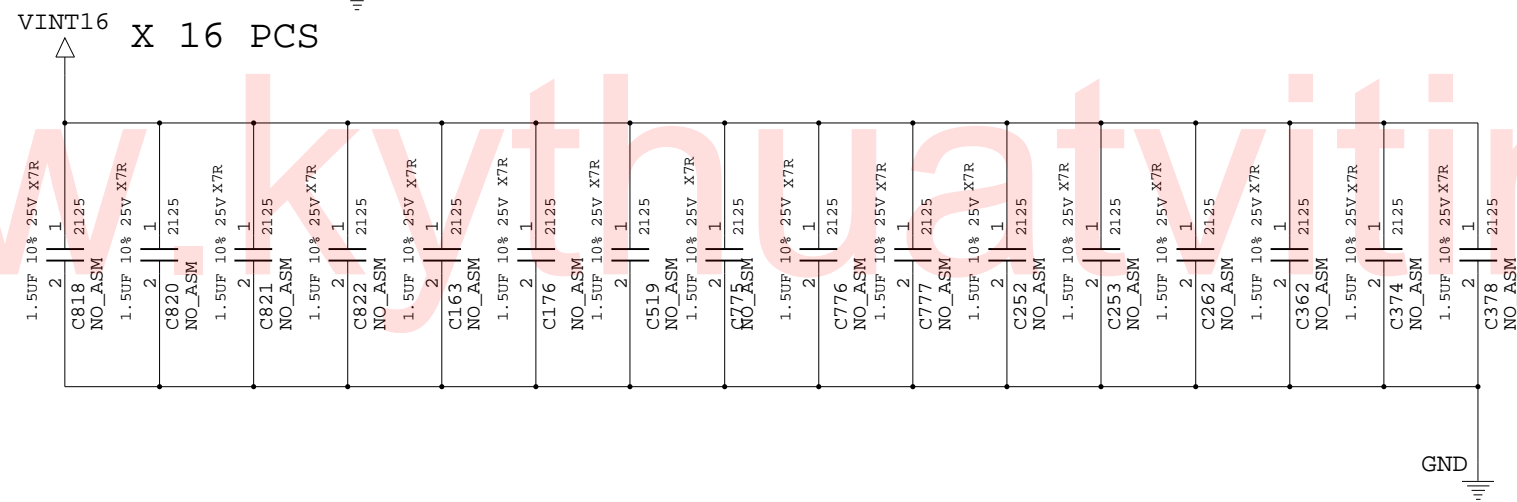
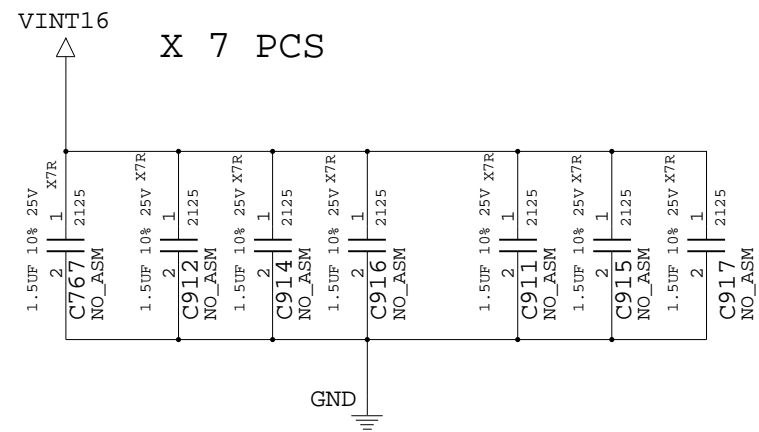

FOLLOWING 7 PCS OF 0.47UF AREA ASM FOR VCCCPUCORE TO REDUCE EMI.

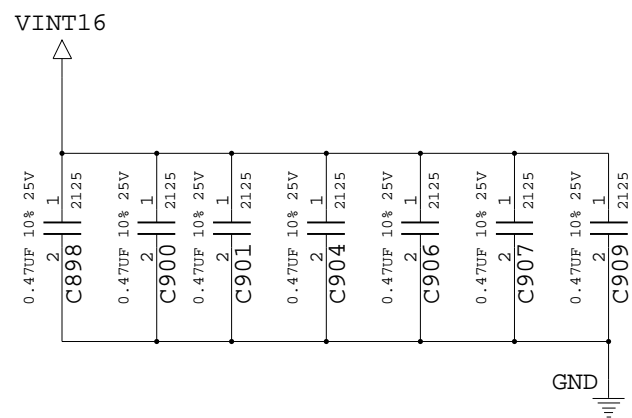

39T0120

DESIGNER	Y.I	NOV/17/04	PART NO.	39T0120	
CHECKED	Y.Y	NOV/17/04			
APPROVED	T.S	NOV/17/04	TITLE ROME-4 SVT(V0.90)		
CLASS	T.S	NOV/17/04	DC-DC VCORE INPUT CAP		
THIS DOCUMENT IS THE PROPERTY OF IBM ITS USE IS AUTHORIZED ONLY FOR RESPONDING TO A REQUEST FOR QUOTATION OR FOR THE PERFORMANCE OF WORK FOR IBM. ALL QUESTIONS MUST BE REFERRED TO THE IBM PURCHASING DEPARTMENT.				IBM CONFIDENTIAL	

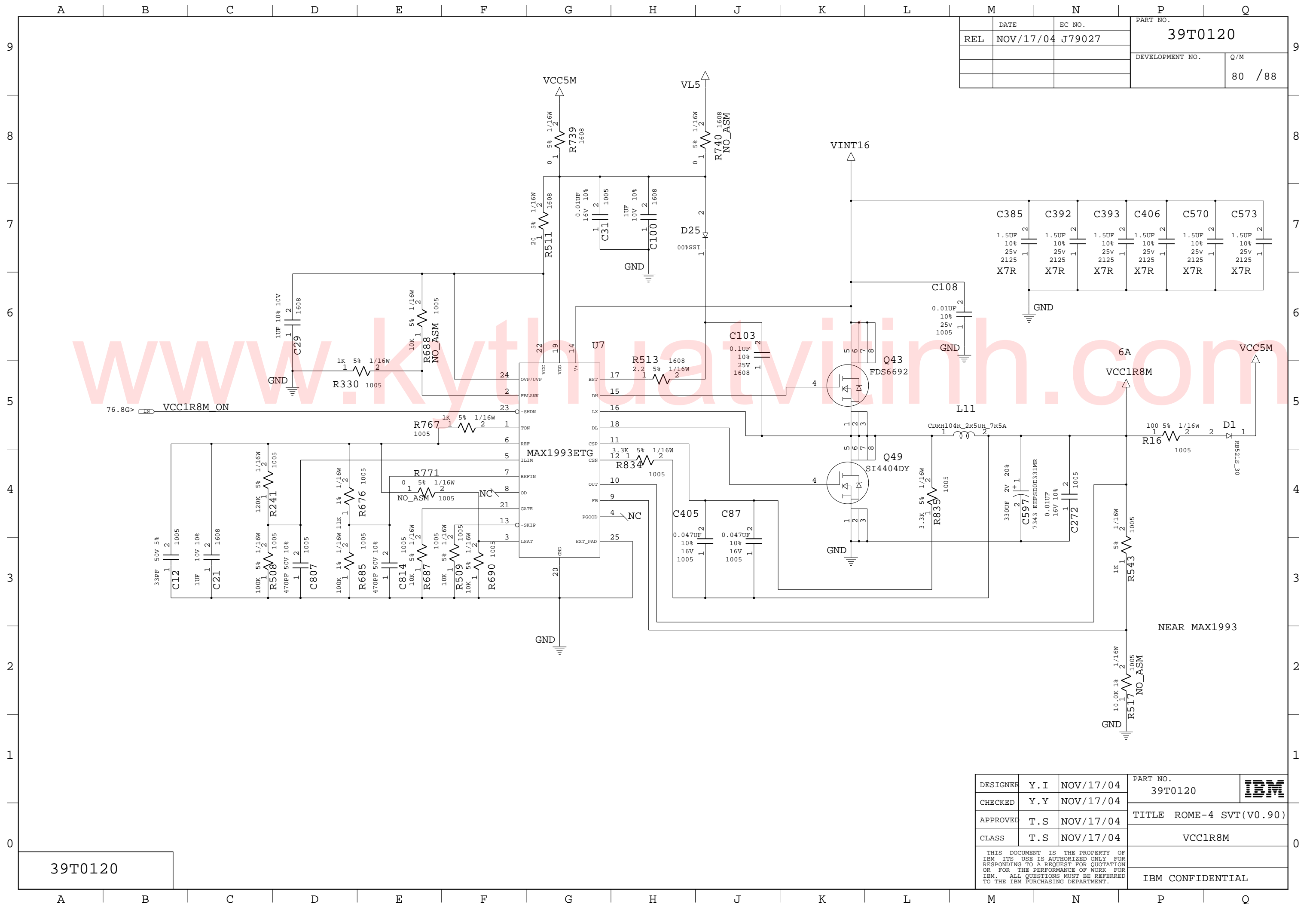

	DATE	EC NO.	PART NO.
REL	NOV/17/04	J79027	39T0120
			DEVELOPMENT NO.
			Q/M
			80 / 88

DESIGNER	Y.I	NOV/17/04	PART NO.	39T0120	IBM
CHECKED	Y.Y	NOV/17/04			
APPROVED	T.S	NOV/17/04	TITLE ROME-4 SVT(V0.90)		
CLASS	T.S	NOV/17/04	VCC1R8M		
THIS DOCUMENT IS THE PROPERTY OF IBM ITS USE IS AUTHORIZED ONLY FOR RESPONDING TO A REQUEST FOR QUOTATION OR FOR THE PERFORMANCE OF WORK FOR IBM. ALL QUESTIONS MUST BE REFERRED TO THE IBM PURCHASING DEPARTMENT.					IBM CONFIDENTIAL

39T0120

NEAR MAX1993



DATE	NOV/17/04	EC NO.	J79027	PART NO.	39T0120
REL				DEVELOPMENT NO.	81 / 88

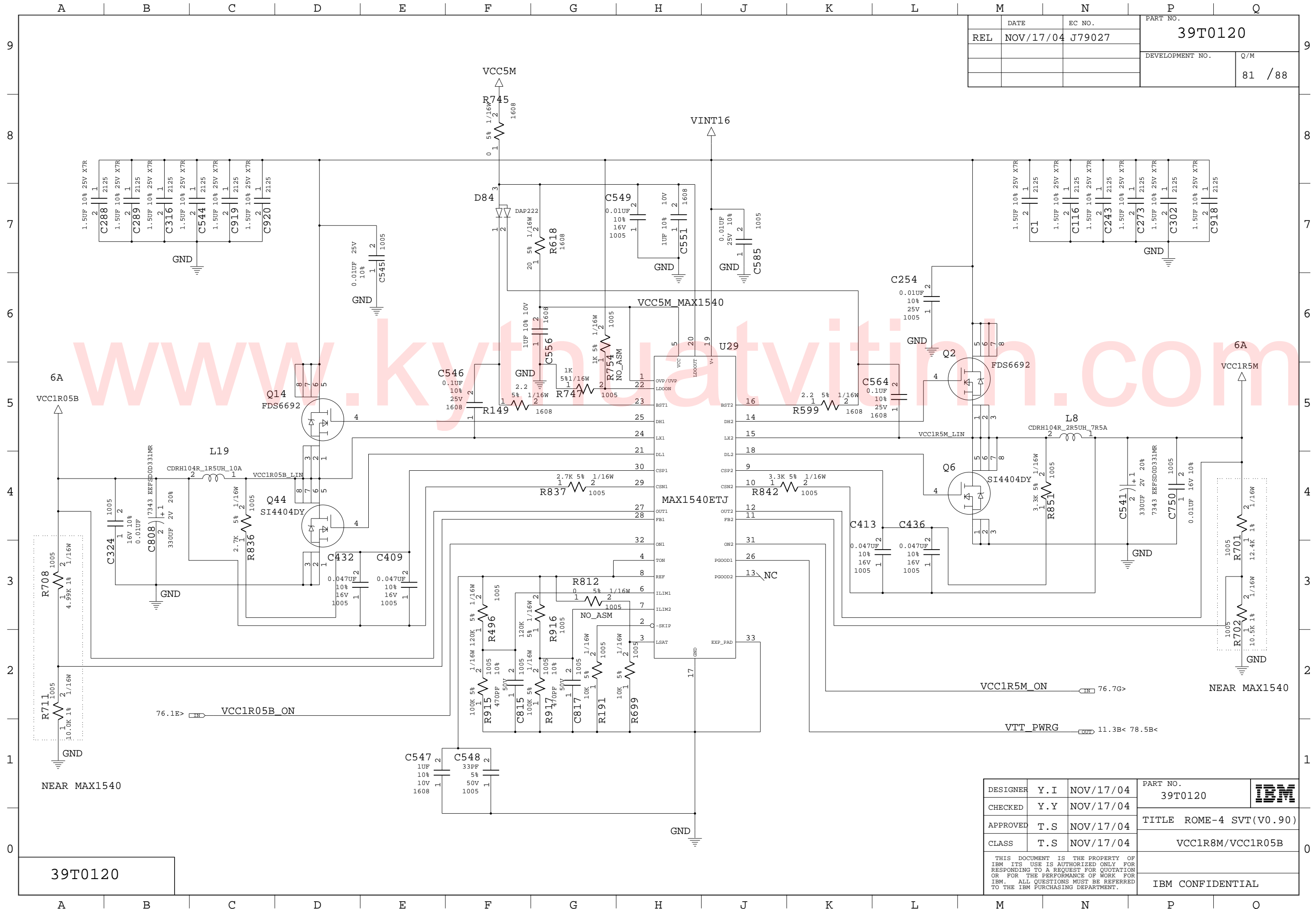

NEAR MAX1540

NEAR MAX1540

DESIGNER	Y.I	NOV/17/04	PART NO.	39T0120	
CHECKED	Y.Y	NOV/17/04	TITLE	ROME-4 SVT(V0.90)	
APPROVED	T.S	NOV/17/04	CLASS	VCC1R8M/VCC1R05B	
THIS DOCUMENT IS THE PROPERTY OF IBM ITS USE IS AUTHORIZED ONLY FOR RESPONDING TO A REQUEST FOR QUOTATION OR FOR THE PERFORMANCE OF WORK FOR IBM. ALL QUESTIONS MUST BE REFERRED TO THE IBM PURCHASING DEPARTMENT.					IBM CONFIDENTIAL

39T0120

REL	DATE	EC NO.	PART NO.
	NOV/17/04	J79027	39T0120
			DEVELOPMENT NO.
			Q/M
			82 / 88

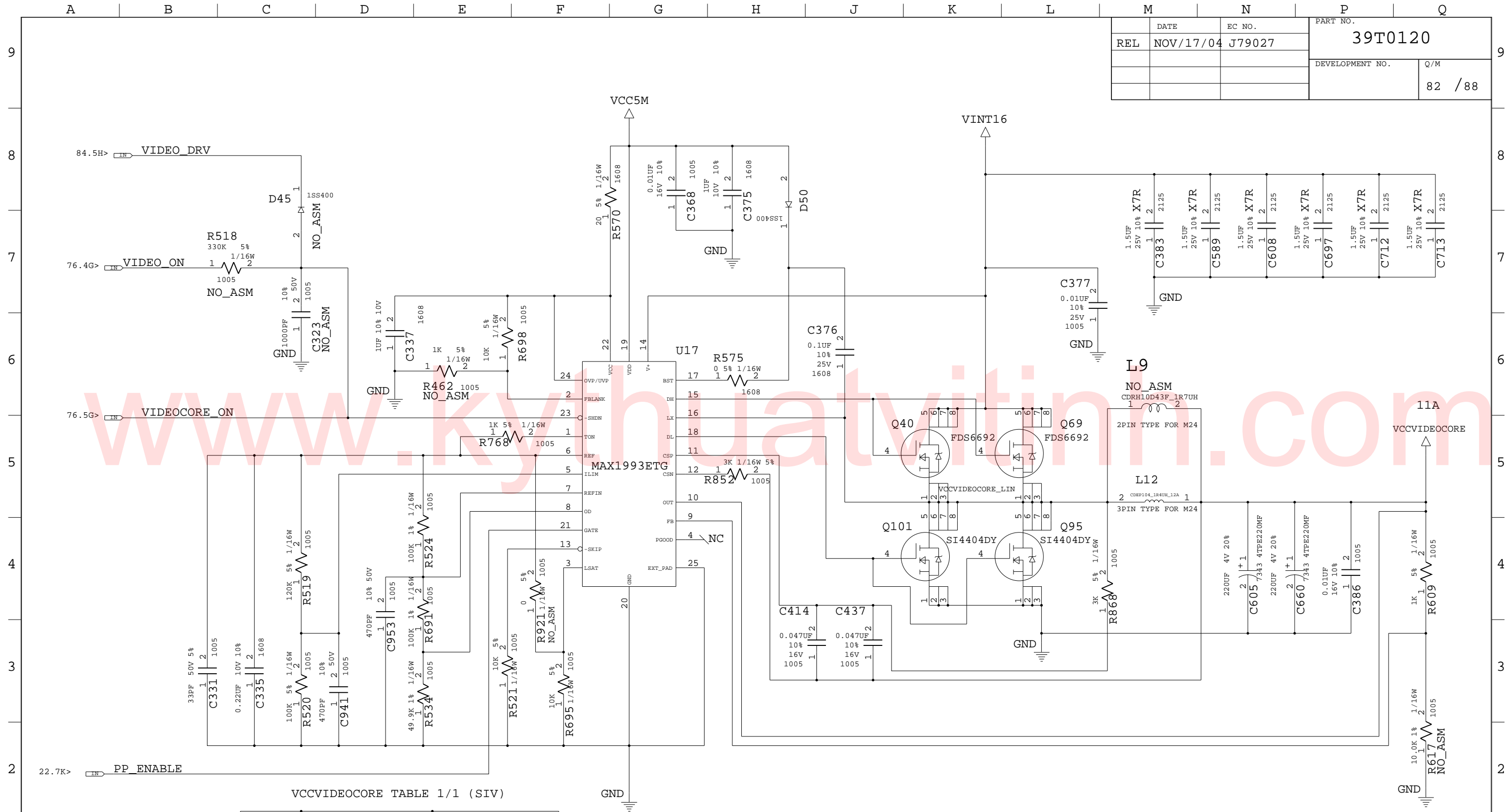

VCCVIDEOCORE TABLE 1/1 (SIV)

	M22 A12 (1.15V)	M24 A22 (1.2V)
R534	35.7K 1%	49.9K 1%

LOGIC

DESIGNER	Y.I	NOV/17/04	PART NO.	39T0120	
CHECKED	Y.Y	NOV/17/04			
APPROVED	T.S	NOV/17/04	TITLE	ROME-4 SVT(V0.90)	
CLASS	T.S	NOV/17/04		VCCVIDEO	
THIS DOCUMENT IS THE PROPERTY OF IBM. ITS USE IS AUTHORIZED ONLY FOR RESPONDING TO A REQUEST FOR QUOTATION OR FOR THE PERFORMANCE OF WORK FOR IBM. ALL QUESTIONS MUST BE REFERRED TO THE IBM PURCHASING DEPARTMENT.				IBM CONFIDENTIAL	

39T0120

NEAR MAX1993

	DATE	EC NO.	PART NO.	
REL	NOV/17/04	J79027	39T0120	
			DEVELOPMENT NO.	Q/M
				83 / 88

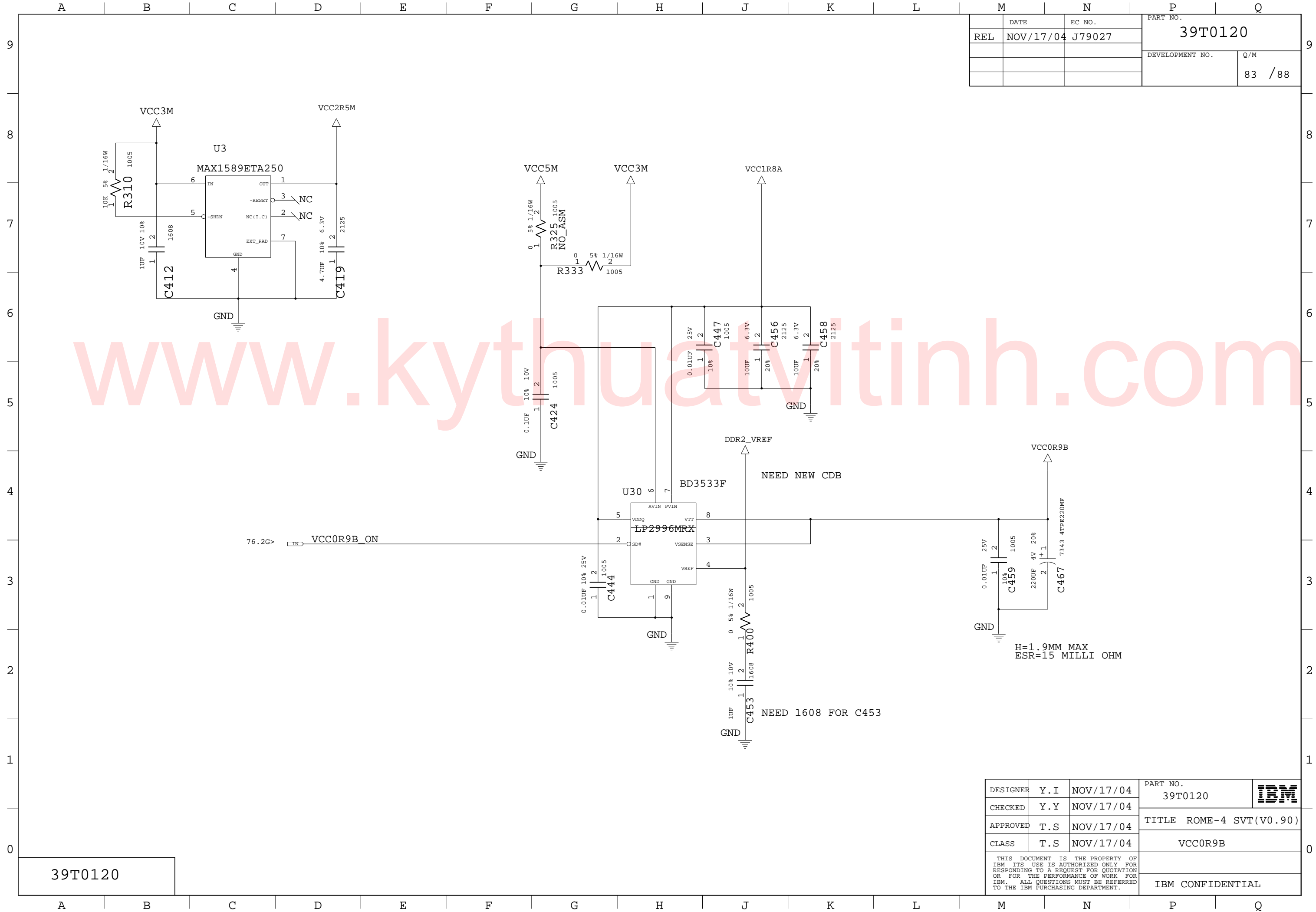

39T0120

DESIGNER	Y.I	NOV/17/04	PART NO.	39T0120	IBM
CHECKED	Y.Y	NOV/17/04			
APPROVED	T.S	NOV/17/04	TITLE ROME-4 SVT(V0.90)		
CLASS	T.S	NOV/17/04	VCC0R9B		
THIS DOCUMENT IS THE PROPERTY OF IBM ITS USE IS AUTHORIZED ONLY FOR RESPONDING TO A REQUEST FOR QUOTATION OR FOR THE PERFORMANCE OF WORK FOR IBM. ALL QUESTIONS MUST BE REFERRED TO THE IBM PURCHASING DEPARTMENT.				IBM CONFIDENTIAL	

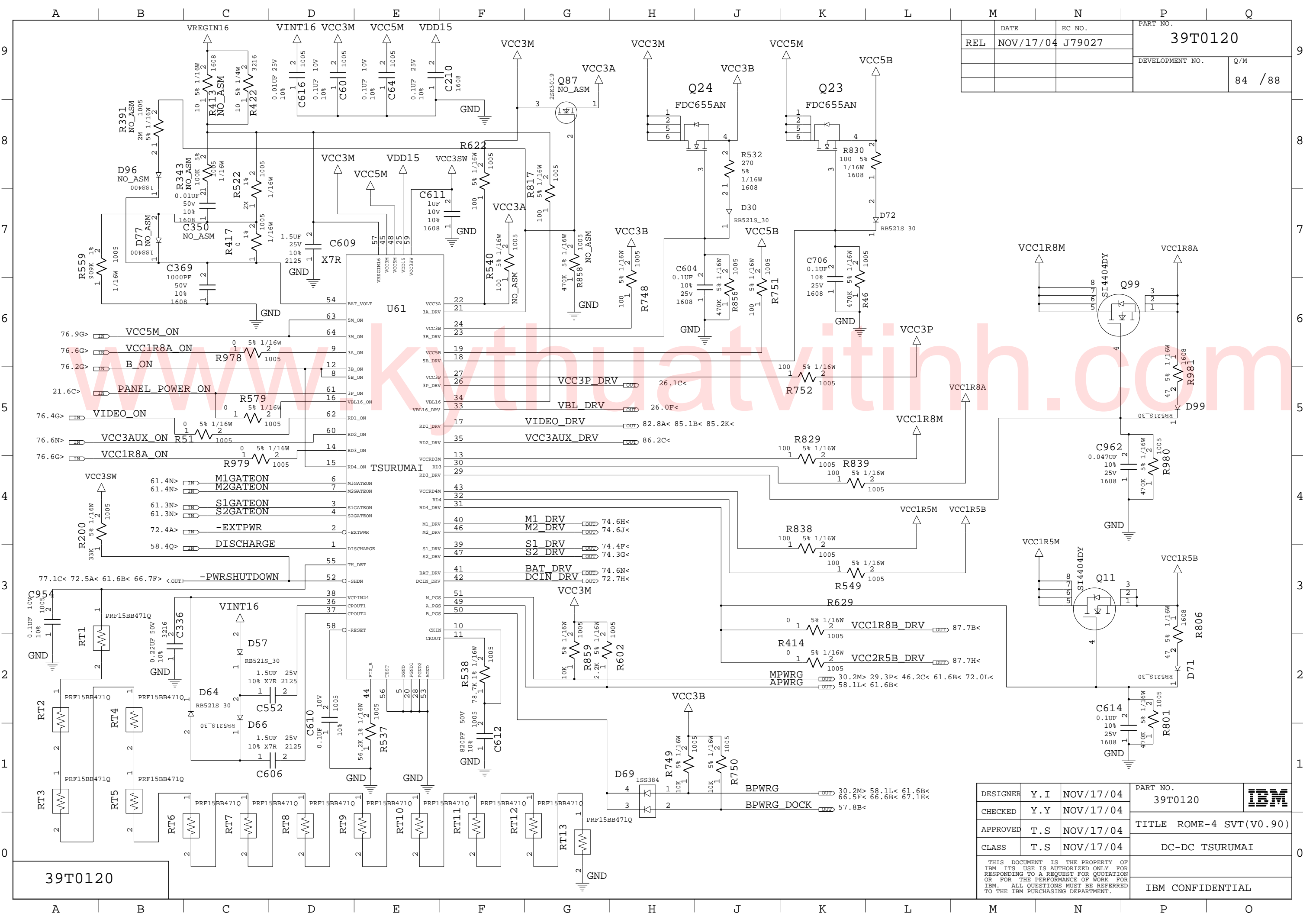

REL	DATE	EC NO.	PART NO.
	NOV/17/04	J79027	39T0120
			DEVELOPMENT NO.
			Q/M
			84 / 88

39T0120

DESIGNER	Y.I	NOV/17/04	PART NO.	39T0120	
CHECKED	Y.Y	NOV/17/04	TITLE	ROME-4 SVT(V0.90)	
APPROVED	T.S	NOV/17/04	CLASS	DC-DC TSURUMAI	
THIS DOCUMENT IS THE PROPERTY OF IBM ITS USE IS AUTHORIZED ONLY FOR RESPONDING TO A REQUEST FOR QUOTATION OR FOR THE PERFORMANCE OF WORK FOR IBM. ALL QUESTIONS MUST BE REFERRED TO THE IBM PURCHASING DEPARTMENT.					IBM CONFIDENTIAL

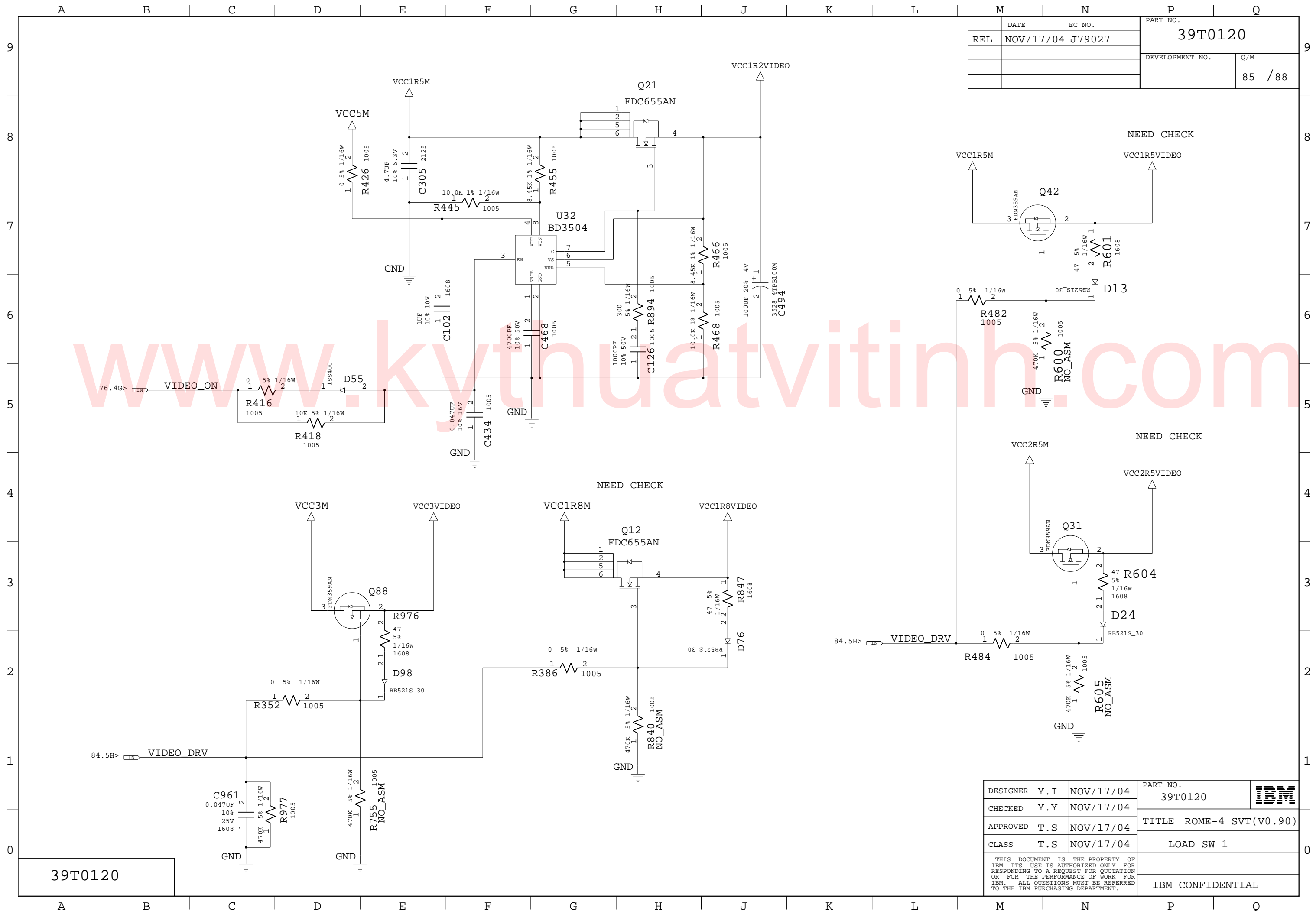

DATE	EC NO.	PART NO.	
REL NOV/17/04	J79027	39T0120	
		DEVELOPMENT NO.	Q/M
			85 / 88

39T0120

DESIGNER	Y.I	NOV/17/04	PART NO.	39T0120	IBM
CHECKED	Y.Y	NOV/17/04			
APPROVED	T.S	NOV/17/04	TITLE ROME-4 SVT(V0.90)		
CLASS	T.S	NOV/17/04	LOAD SW 1		
THIS DOCUMENT IS THE PROPERTY OF IBM ITS USE IS AUTHORIZED ONLY FOR RESPONDING TO A REQUEST FOR QUOTATION OR FOR THE PERFORMANCE OF WORK FOR IBM. ALL QUESTIONS MUST BE REFERRED TO THE IBM PURCHASING DEPARTMENT.					IBM CONFIDENTIAL

	DATE	EC NO.	PART NO.
REL	NOV/17/04	J79027	39T0120
			DEVELOPMENT NO.
			Q/M
			86 / 88

76.8N> VCC1R2AUX\_ON

84.5H> VCC3AUX\_DRV

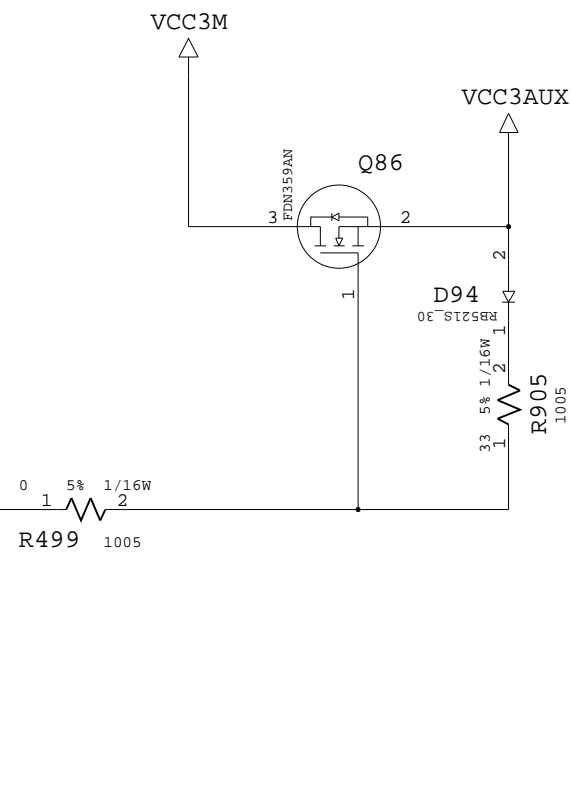
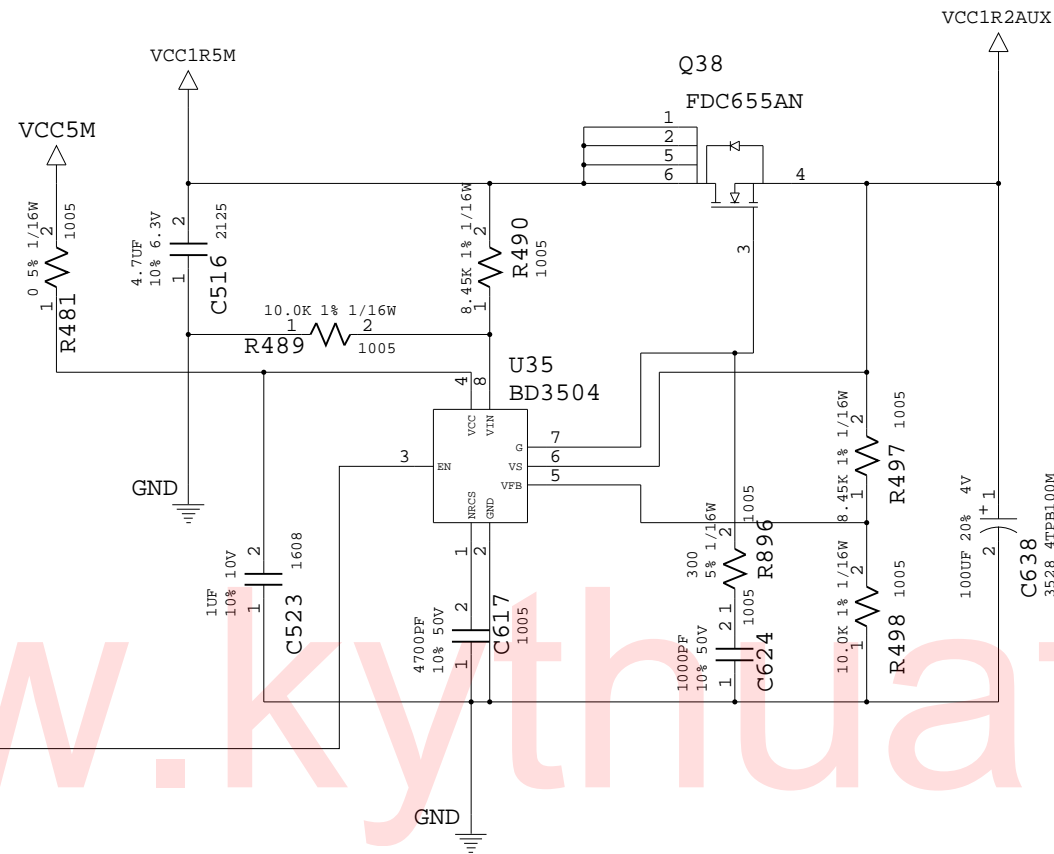

39T0120

DESIGNER	Y.I	NOV/17/04	PART NO.	IBM
CHECKED	Y.Y	NOV/17/04	39T0120	
APPROVED	T.S	NOV/17/04	TITLE ROME-4 SVT(V0.90)	
CLASS	T.S	NOV/17/04	LOAD SW 2	
THIS DOCUMENT IS THE PROPERTY OF IBM ITS USE IS AUTHORIZED ONLY FOR RESPONDING TO A REQUEST FOR QUOTATION OR FOR THE PERFORMANCE OF WORK FOR IBM. ALL QUESTIONS MUST BE REFERRED TO THE IBM PURCHASING DEPARTMENT.				IBM CONFIDENTIAL



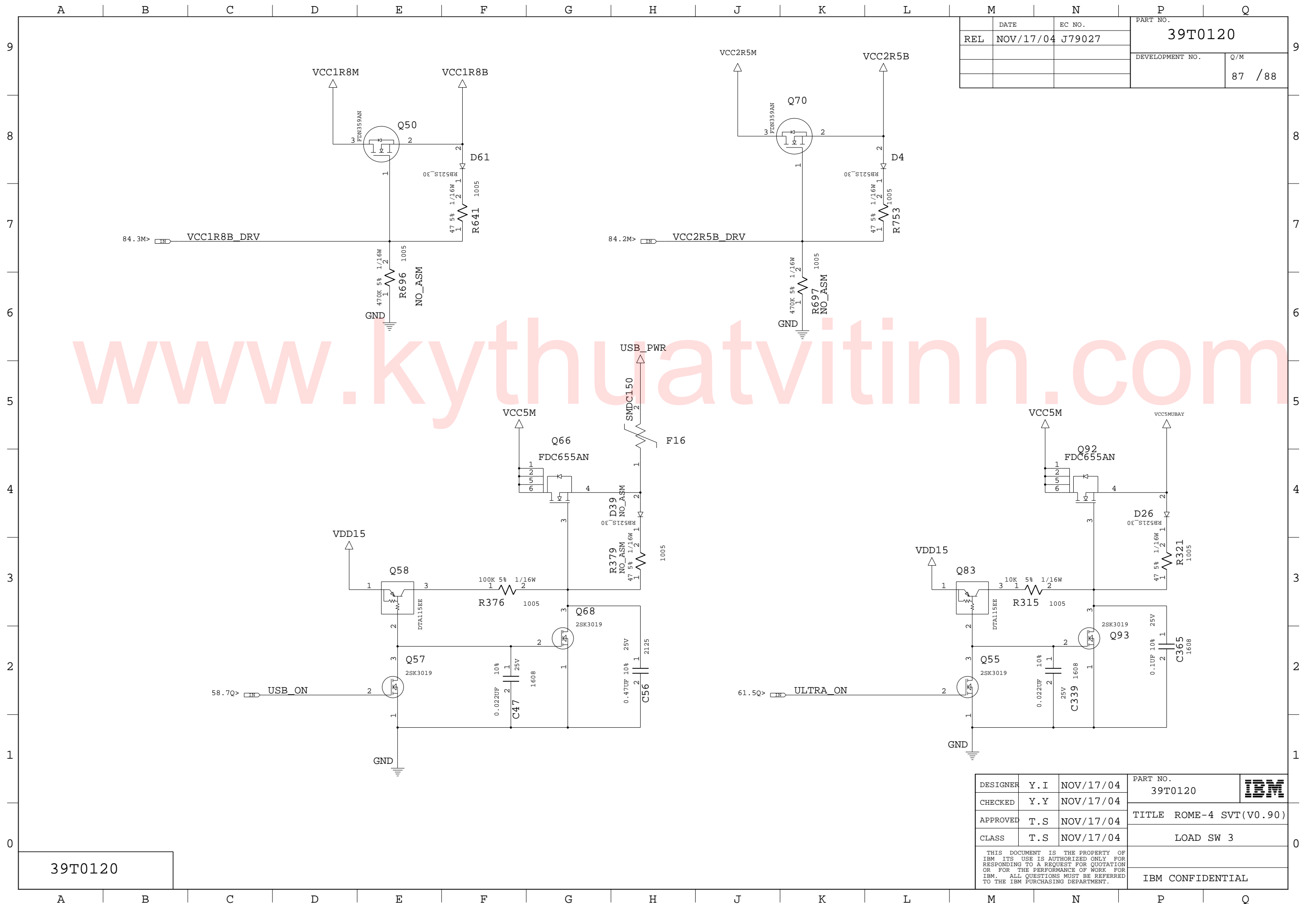

	DATE	EC NO.	PART NO.
REL	NOV/17/04	J79027	39T0120
			DEVELOPMENT NO.
			Q/M
			87 / 88

39T0120

DESIGNER	Y.I	NOV/17/04	PART NO.	39T0120	IBM
CHECKED	Y.Y	NOV/17/04			
APPROVED	T.S	NOV/17/04	TITLE ROME-4 SVT(V0.90)		
CLASS	T.S	NOV/17/04	LOAD SW 3		
THIS DOCUMENT IS THE PROPERTY OF IBM. ITS USE IS AUTHORIZED ONLY FOR RESPONDING TO A REQUEST FOR QUOTATION OR FOR THE PERFORMANCE OF WORK FOR IBM. ALL QUESTIONS MUST BE REFERRED TO THE IBM PURCHASING DEPARTMENT.					IBM CONFIDENTIAL

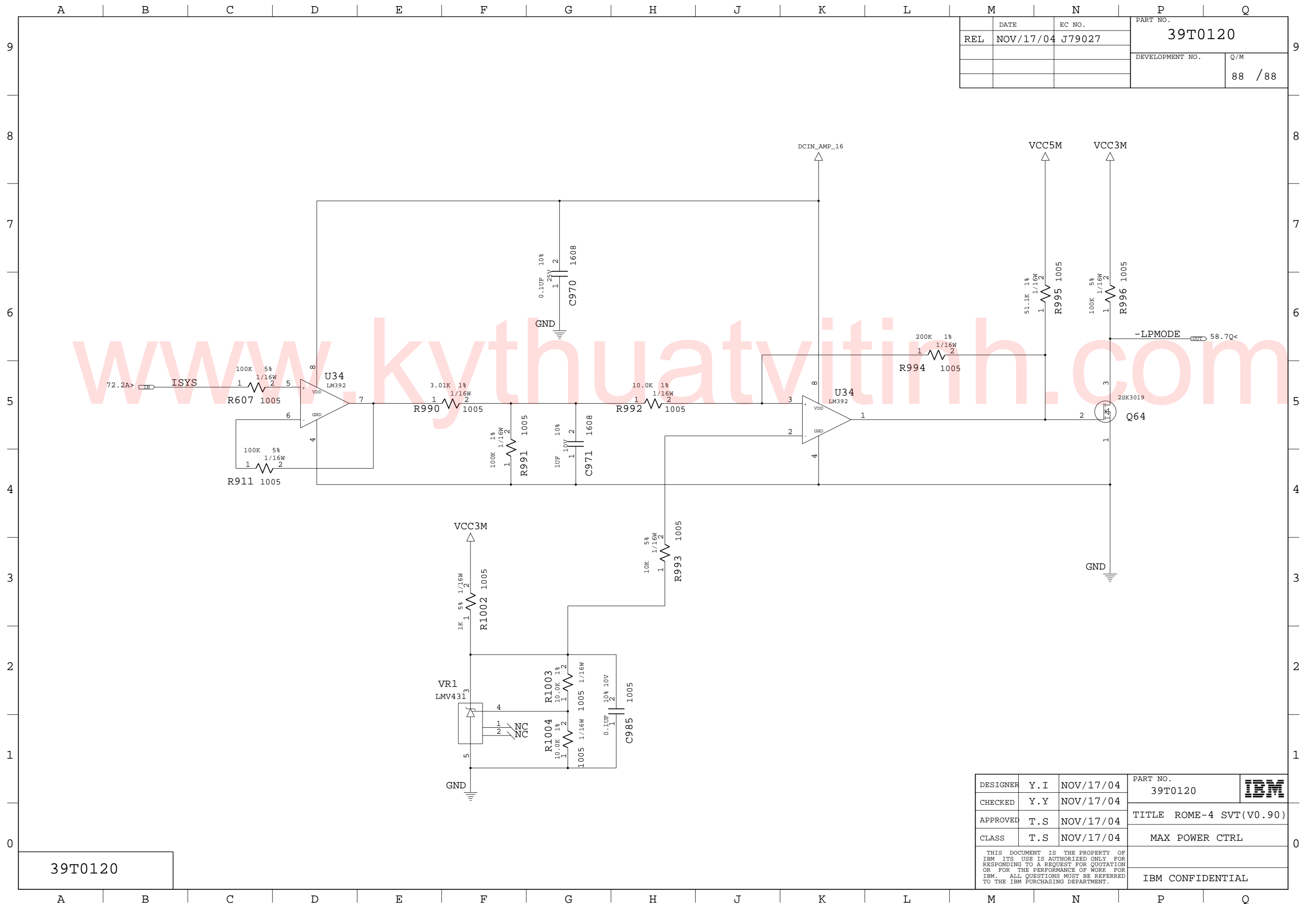

REL	DATE	EC NO.	PART NO.	
	NOV/17/04	J79027	39T0120	
			DEVELOPMENT NO.	Q/M
			88	/88

39T0120

DESIGNER	Y. I	NOV/17/04	PART NO.	39T0120	
CHECKED	Y. Y	NOV/17/04			
APPROVED	T. S	NOV/17/04	TITLE ROME-4 SVT(V0.90)		
CLASS	T. S	NOV/17/04	MAX POWER CTRL		
THIS DOCUMENT IS THE PROPERTY OF IBM ITS USE IS AUTHORIZED ONLY FOR RESPONDING TO A REQUEST FOR QUOTATION OR FOR THE PERFORMANCE OF WORK FOR IBM. ALL QUESTIONS MUST BE REFERRED TO THE IBM PURCHASING DEPARTMENT.				IBM CONFIDENTIAL	